

SCIENTIFIC CALCULATOR OPERATION GUIDE

< EL-520TS >

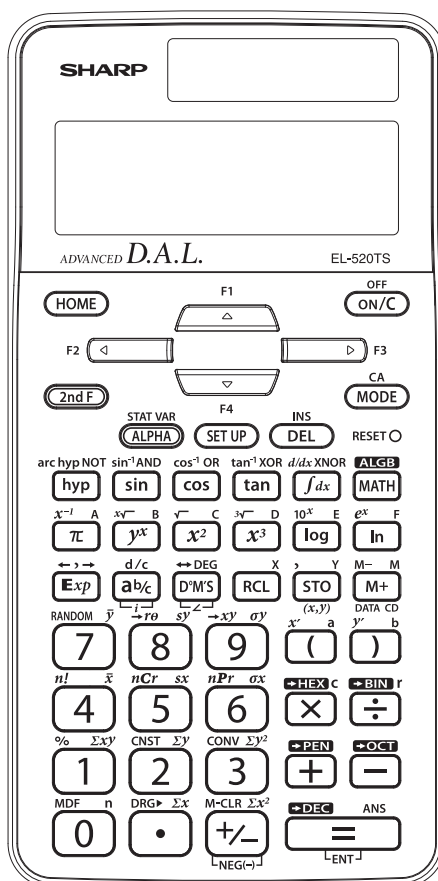

SHARP

CONTENTS

HOW TO OPERATE

Read Before Using

Key layout		4
Reset switch/Display pattern		5
Display format and decimal setting function		5-6
Exponent display		6
Angular unit		7

Functions and Key Operations

ON/OFF, entry correction keys		8
Data entry keys		9
Random key		10
Modify key		11
Basic arithmetic keys, parentheses		12
Percent		13
Inverse, square, cube, xth power of y, square root, cube root, xth root		14
10 to the power of x, common logarithm		15
e to the power of x, natural logarithm		16
Factorials		17
Permutations, combinations		18
Time calculation		19
Fractional calculations		20
Memory calculations		21
Last answer memory		22
Formula memories	~	23
Trigonometric functions		24-26
Arc trigonometric functions		27
Hyperbolic functions		28
Coordinate conversion		29
Binary, pental, octal, decimal, and hexadecimal operations (N-base)		30

CONTENTS

Differentiation calculation	$\frac{d}{dx}$ X x^2	31
Integration calculation	$\int dx$ X x^2	32
Simulation calculation	ALGB	33
Statistics functions	MODE (x,y) DATA CD	34
Data input for 1-variable statistics		34
“ANS” keys for 1-variable statistics		35
Data correction		36-37
Data input for 2-variable statistics		38
“ANS” keys for 2-variable statistics		39
Simultaneous calculation	MODE	40
Complex calculation	MODE $\rightarrow xy$ $\rightarrow re$ $\left\{ \begin{matrix} \\ i \end{matrix} \right\}$	41

How to Operate

≈Read Before Using≈

This operation guide has been written based on the EL-520TS model.

1. KEY LAYOUT

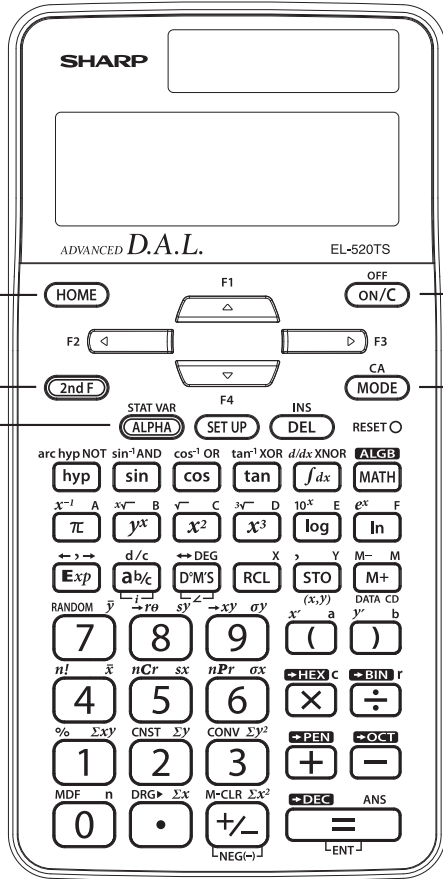

● 2nd function, ALPHA keys

Pressing these keys will enable the functions written in orange (2nd F) or green (ALPHA) above the calculator buttons.

ON/C, OFF key

ON/C <Power on>

2ndF **OFF** <Power off>
Written in orange above the ON/C key

● HOME key

Pressing this key will return to NORMAL mode.

MATH Various functions

● Mode key

This calculator can operate in six different modes as follows.

[NORMAL mode] • Mode = 0; normal mode for performing normal arithmetic and function calculations.

MODE **0**

[STAT mode] • Mode = 1; mode for performing 1- or 2-variable statistical calculations. To select the sub-mode, press the corresponding number key after **MODE** **1**.

MODE **1**

- 0** (SD): Single variable statistic calculation
- 1** (LINE): Linear regression calculation
- 2** (QUAD): Quadratic regression calculation
- 3** (EXP): Exponential regression calculation
- 4** (LOG): Logarithmic regression calculation
- 5** (POWER): Power regression calculation
- 6** (INV): Inverse regression calculation

[EQN mode] • Mode = 2; mode for equation solvers. To select the sub-mode, press the corresponding number key after **MODE** **2**.

MODE **2**

- 0** (2-VLE): Simultaneous linear equation with two unknowns
- 1** (3-VLE): Simultaneous linear equation with three unknowns
- 2** (QUAD): Quadratic equation ($ax^2 + bx + c = 0$)
- 3** (CUBIC): Cubic equation ($ax^3 + bx^2 + cx + d = 0$)

[CPLX mode] • Mode = 3; mode for complex number calculations.

MODE **3**

2. RESET SWITCH

If the calculator fails to operate normally, press the reset switch on the front to reinitialise the unit. The display format and calculation mode will return to their initial settings.

NOTE:

Pressing the reset switch will erase any data stored in memory.

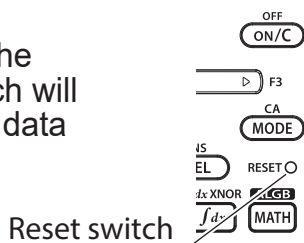

3. DISPLAY PATTERN

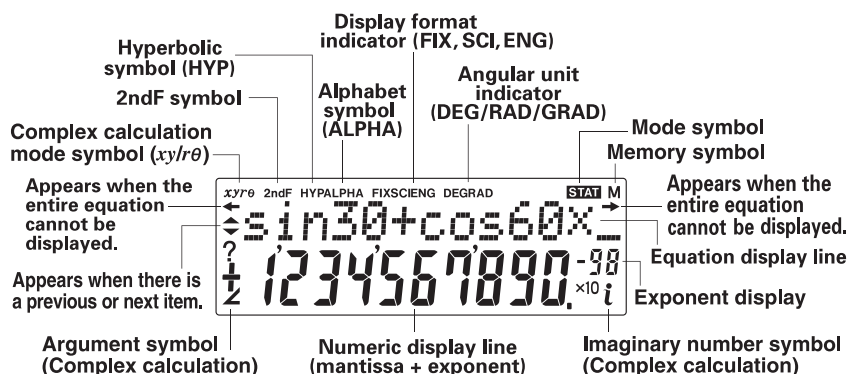

The actual display does not appear like this. This illustration is for explanatory purposes only.

4. DISPLAY FORMAT AND DECIMAL SETTING FUNCTION

For convenient and easy operation, this model can be used in one of five display modes. The selected display status is shown in the upper part of the display (Display format indicator). Note: If more 0's (zeros) than needed are displayed when the ON/C key is pressed, check whether or not the calculator is set to a Special Display Format.

- **Floating decimal point format 1/2** (no symbol is displayed) *1
Valid values beyond the maximum range are displayed in the form of [10-digit (mantissa) + 2-digit (exponent)]
- **Fixed decimal point format (FIX is displayed)**
Displays the fractional part of the calculation result according to the specified number of decimal places.
- **Scientific notation (SCI is displayed)**
Frequently used in science to handle extremely small or large numbers.
- **Engineering scientific notation (ENG is displayed)**
Convenient for converting between different units.

- *1 The calculator has two settings for displaying a floating point number: **NORM1 (default setting)** and **NORM2**. In each display setting, a number is automatically displayed in scientific notation outside a preset range:
- NORM1: $0.000000001 \leq x \leq 9999999999$
 - NORM2: $0.01 \leq x \leq 9999999999$

<Example> Let's compare the display result of $[10000 \div 8.1 =]$ in each display format.

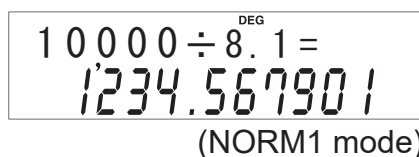
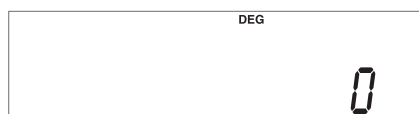

SET UP 1 0 SET UP 2 3

Display format indicator
 $10000 \div 8.1 =$
 1234.568
 (FIX mode, TAB=3)

SET UP 1 1

$10000 \div 8.1 =$
 1.235×10^3
 (SCI mode)

SET UP 1 2

$10000 \div 8.1 =$
 1.235×10^3
 (ENG mode)

SET UP 1 3

$10000 \div 8.1 =$
 1234.567901
 (NORM1 mode)

5. EXPONENT DISPLAY

The distance from the earth to the sun is approx. 150,000,000 (1.5×10^8) km. Values such as this with many zeros are often used in scientific calculations, but entering the zeros one by one is a great deal of work and it's easy to make mistakes. In such cases, the numerical values are divided into mantissa and exponent portions, displayed and calculated.

<Example> What is the number of electrons flowing in a conductor when the electrical charge across a given cross-section is 0.32 coulombs. (The charge on a single electron = 1.6×10^{-19} coulombs).

0.32 \div

$0.32 \div _$
 0.

1.6 Exp 19

$0.32 \div _$
 1.6×10^{19}

=

$0.32 \div 1.6 \text{E} 19 =$
 $2. \times 10^{-20}$

6. ANGULAR UNIT

Angular values are converted from DEG to RAD to GRAD with each push of the DRG► key (2nd function of \square). This function is used when doing calculations related to trigonometric functions or coordinate geometry conversions.

Degrees (DEG is shown at the top of the display)

A commonly used unit of measure for angles. The angular measure of a circle is expressed as 360° .

Radians (RAD is shown at the top of the display)

Radians are different from degrees and express angles based on the circumference of a circle. 180° is equivalent to π radians. Therefore, the angular measure of a circle is 2π radians.

Grads (GRAD is shown at the top of the display)

Grads are a unit of angular measure used in Europe, particularly in France. An angle of 90 degrees is equivalent to 100 grads.

The relationships between the three types of angular units can be expressed as right:

$$\begin{aligned} 90^\circ \text{ (DEG)} &= \\ \pi/2 \text{ (RAD)} &= \\ 100 \text{ (GRAD)} &= \end{aligned}$$

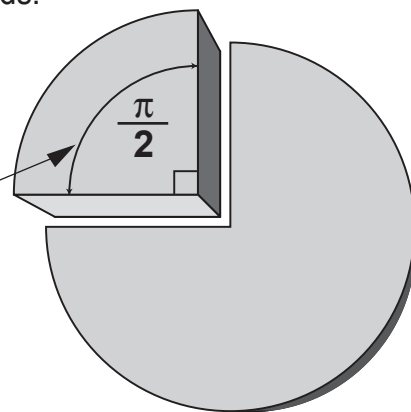

<Example> Check to confirm 90 degrees equalling $\pi/2$ radians equalling 100 grads. ($\pi=3.14159\dots$)

Operation	Display
SET UP \square \square \square (Select DEG mode)	Angular unit indicator DEG 0.
90 2ndF DRG►	90 ► RAD 1.570796327 ($\pi/2$)
2ndF DRG►	ANS ► GRAD 100.
2ndF DRG►	ANS ► DEG 90.

≈Functions and Key Operations≈

ON/OFF, Entry Correction Keys

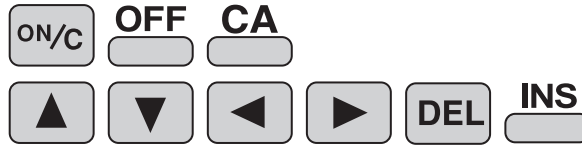

Turns the calculator on or clears the data. It also clears the contents of the calculator display and voids any calculator command; however, statistics, as well as values stored in the memory, are not erased.



Turns the calculator off.



Clears all internal values, including the last answer (ANS) and statistics. Values stored in M memory in normal mode are not erased.



These arrow keys are useful for Multi-Line playback, which lets you scroll through calculation steps one by one.



These keys are useful for editing equations. The key moves the cursor to the left, and the key moves the cursor to the right.



The key deletes the symbol/number at the cursor.



The key inserts the symbol/number at the cursor.

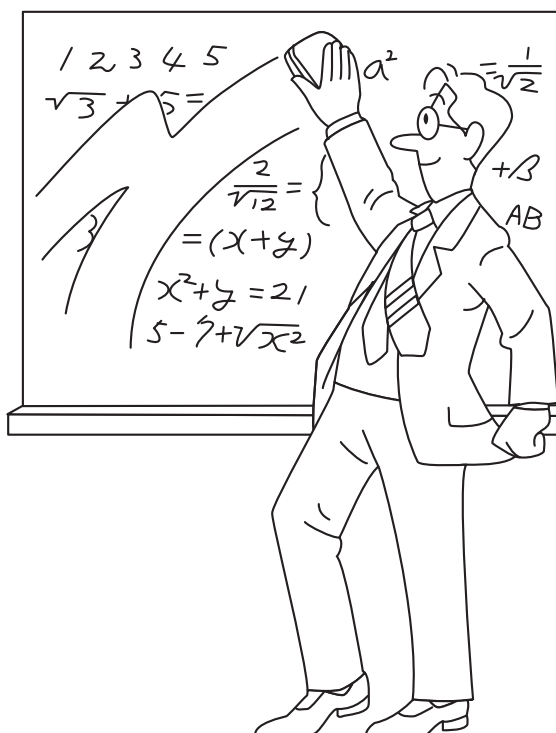

Data Entry Keys



0 to 9 Numeric keys for entering data values.



Decimal point key. Enters a decimal point.



Enters the minus symbol or sign change key.
Changes positive numbers to negative and negative numbers to positive.



Enters π (3.14159...).
The constant π , used frequently in function calculations, is the ratio of the circumference of a circle to its diameter



Pressing this key switches to scientific notation data entry.

<Example> Provided the earth is moving around the sun in a circular orbit, how many kilometers will it travel in a year?

* The average distance between the earth and the sun being 1.496×10^8 km.

Circumference equals diameter $\times \pi$; therefore,
 $1.496 \times 10^8 \times 2 \times \pi$

Operation

1 496 8

2

Display

DEG
1.496 ⁰⁸_{x10}

DEG
1.496 E 08 $\times 2 \times \pi \rightarrow$
939964522.

Random Key





RANDOM  Generates random numbers.

Random numbers are three-decimal-place values between 0.000 and 0.999. Using this function enables the user to obtain unbiased sampling data derived from random values generated by the calculator.





<Example>

    0.*** (A random number is generated.)





[Random Dice]

To simulate a die-rolling, a random integer between 1 and 6 can be generated by pressing    . To generate the next random dice number, press .

[Random Coin]

To simulate a coin flip, 0 (heads) or 1 (tails) can be randomly generated by pressing    . To generate the next random coin number, press .

[Random Integer]

An integer between 0 and 99 can be generated randomly by pressing    . To generate the next random integer, press .

APPLICATIONS:

Building sample sets for statistics or research.

Modify Key

MDF  Function to round calculation results.

Even after setting the number of decimal places on the display, the calculator performs calculations using a larger number of decimal places than that which appears on the display.

By using this function, internal calculations will be performed using only the displayed value.

<Example> FIX mode TAB = 1 (normal calculation)

$$5 \div 9 = 0.6 \text{ (internally, } 0.5555\dots)$$
$$\times 9 = 5.0$$

Rounded calculation (MDF)

$$5 \div 9 = 0.6 \text{ (internally, } 0.5555\dots)$$
$$\text{2ndF } \text{MDF} \text{ (internally, } 0.6)$$
$$\times 9 = 5.4$$

APPLICATIONS:

Frequently used in scientific and technical fields, as well as business, when performing chained calculations.

Basic Arithmetic Keys, Parentheses

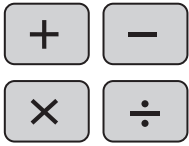
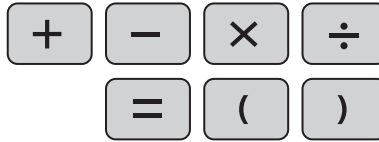

The four basic operators. Each is used in the same way as a standard calculator:

+ (addition), - (subtraction), x (multiplication), and ÷ (division).



Finds the result in the same way as a standard calculator.



Used to specify calculations in which certain operations have precedence. You can make addition and subtraction operations have precedence over multiplication and division by enclosing them in parentheses.

Percent

For calculating percentages. Four methods of calculating percentages are presented as follows.

1) \$125 increased by 10%...137.5

125 + 10 2ndF %

1 2 5 + 1 0 % ^{DEG}
137.5

2) \$125 reduced by 20%...100

125 - 20 2ndF %

1 2 5 - 2 0 % ^{DEG}
100.

3) 15% of \$125...18.75

125 × 15 2ndF %

1 2 5 × 1 5 % ^{DEG}
18.75

4) When \$125 equals 5% of X, X equals...2500

125 ÷ 5 2ndF %

1 2 5 ÷ 5 % ^{DEG}
2500.

Inverse, Square, Cube, xth Power of y, Square Root, Cube Root, xth Root

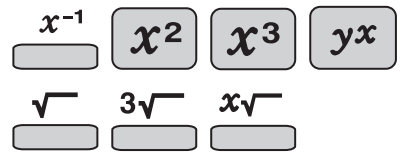

x^{-1} Calculates the inverse of the value.

x^2 Squares the value.

x^3 Cubes the value.

yx Calculates exponential values.

$\sqrt{}$ Calculates the square root of the value.

$\sqrt[3]{}$ Calculates the cube root of the value.

$\sqrt[x]{}$ Calculates the x^{th} root of the value.

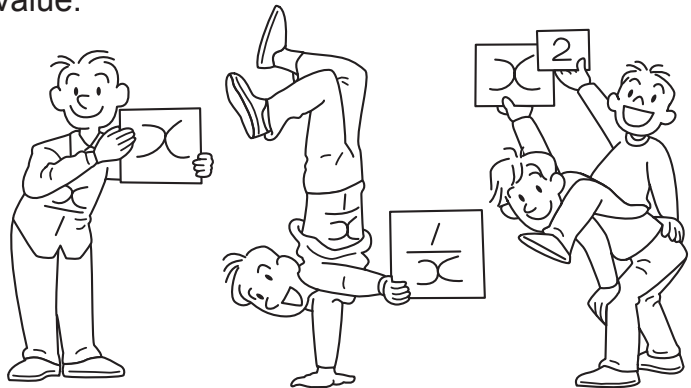

<Example>

Operation

2 \times 2 \times 2 \times 2 =

Display

2 \times 2 \times 2 \times 2 = ^{DEG} 16.

2 yx 4 =

2⁴ = ^{DEG} 16.

4 $2^{nd}F$ $\sqrt[x]{}$ 16 =

4 \times $\sqrt{16}$ = ^{DEG} 2.

10 to the Power of x, Common Logarithm



Calculates the value of 10 raised to the x^{th} power.



Calculates the logarithm, the exponent of the power to which 10 must be raised to equal the given value.

<Example>

Operation



Display

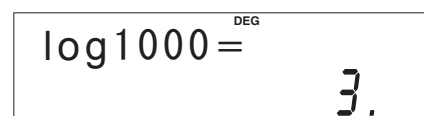
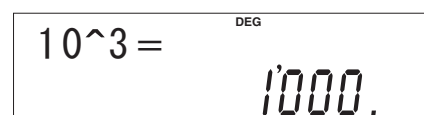

e to the Power of x, Natural Logarithm

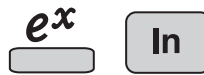

Calculates powers based on the constant e (2.718281828).



Computes the value of the natural logarithm, the exponent of the power to which e must be raised to equal the given value.

<Example>

Operation



Display

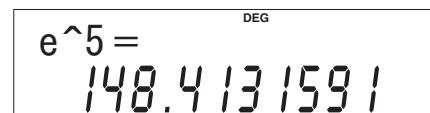

Factorials $n!$

$n!$ The product of a given positive integer n multiplied by all the lesser positive integers from 1 to $n-1$ is indicated by $n!$ and called the factorial of n .

<Example 1>

Operation

Display

7 **2ndF** $n!$ **=**

7! = ^{DEG}
5040.

c.f
 $n! = 1 \times 2 \times 3 \times \dots \times n$

<Example 2> How many arrangements exist of cards of three colors: red, blue, and yellow?

$$3! = 3 \times 2 \times 1 = 6$$

Operation

Display

ON/C 3 **2ndF** $n!$
=

3! = ^{DEG}
6.

APPLICATIONS:

Used in statistics and mathematics. In statistics, this function is used in calculations involving combinations and permutations.

Permutations, Combinations nPr nCr

nPr
 This function finds the number of different possible orderings in selecting r objects from a set of n objects. For example, there are six different ways of ordering the letters ABC in groups of three letters—ABC, ACB, BAC, BCA, CAB, and CBA.
 The calculation equation is ${}_3P_3 = 3 \times 2 \times 1 = 6$ (ways).

nCr
 This function finds the number of ways of selecting r objects from a set of n objects. For example, from the three letters ABC, there are three ways we can extract groups of two different letters—AB, AC, and CB.
 The calculation equation is ${}_3C_2$.

<Example>

	<u>Operation</u>	<u>Display</u>
	6 2ndF nPr 4 =	6P4 = ^{DEG} 360.
	6 2ndF nCr 4 =	6C4 = ^{DEG} 15.

APPLICATIONS:

Used in statistics (probability calculations) and in simulation hypotheses in fields such as medicine, pharmaceuticals, and physics. Also, can be used to determine the chances of winning in lotteries.

Time Calculation ↔DEG D°M'S

↔DEG

Converts a sexagesimal value displayed in degrees, minutes, seconds to decimal notation. Also, converts a decimal value to sexagesimal notation (degrees, minutes, seconds).

D°M'S

Inputs values in sexagesimal notation (degrees, minutes, seconds).

<Example> Convert 24° 28' 35" (24 degrees, 28 minutes, 35 seconds) to decimal notation. Then convert 24.476° to sexagesimal notation.

Operation

Display

24 D°M'S 28 D°M'S 35

DEG
24°28'35"

2ndF ↔DEG

Convert to decimal notation

DEG
24°28'35" =
24.47638889

2ndF ↔DEG

Repeat last key operation to return to the previous display.

DEG
24°28'35" =
24°28'35"

APPLICATIONS:

Used in calculations of angles and angular velocity in physics, and latitude and longitude in geography.

Fractional Calculations ab/c d/c

ab/c Inputs fractions and converts mutually between fractions and decimals.

d/c Converts between mixed numbers (fractions) and improper fractions.

<Example> Add $3\frac{1}{2}$ and $\frac{5}{7}$, and convert to decimal notation.

Operation	Display
3 ab/c 1 ab/c 2 + 5 ab/c 7 =	$3 \frac{1}{2} + 5 \frac{7}{7} =$ $4 \frac{3}{7} 14.$
ab/c	$3 \frac{1}{2} + 5 \frac{7}{7} =$ 4.214285714

Convert to decimal notation.
Press once to return to the fraction.

2ndF d/c	$3 \frac{1}{2} + 5 \frac{7}{7} =$ $59 \frac{14}{7}$
--	--

Convert to an improper fraction.
Press once to return to the mixed number (fraction).

2ndF d/c	$3 \frac{1}{2} + 5 \frac{7}{7} =$ $4 \frac{3}{7} 14.$
--	--

APPLICATIONS:

There is a wide variety of applications for this function because fractions are such a basic part of mathematics. This function is useful for calculations involving electrical circuit resistance.

Memory Calculations

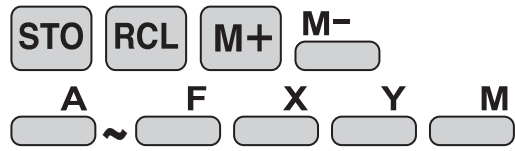

STO

Stores displayed values in memories A~F, X, Y, M.

RCL

Recalls values stored in A~F, X, Y, M.

M+

Adds the displayed value to the value in the independent memory M.

M-

Subtracts the displayed value from the value in the independent memory M.

A

~

F

X

Y

Temporary memories

M

Independent memory

<Example 1>

Operation

0 **STO** **M**
(Enter 0 for M)

25 **×** 27 **M+**

7 **×** 3 **M+**

RCL **M**

Display

0 ⇒ M ^{DEG}
0.

25 × 27 M+ ^{DEG} ^M
675.

7 × 3 M+ ^{DEG} ^M
21.

M= ^{DEG} ^M
696.

<Example 2>

Calculates \$/¥ at the designated exchange rate.

\$1 = ¥110

¥26,510 = \$?

\$2,750 = ¥?

Operation

110 **STO** **Y**

26510 **÷** **RCL** **Y** **=**

2750 **×** **RCL** **Y** **=**

Display

110 ⇒ Y ^{DEG}
110.

26510 ÷ Y = ^{DEG}
241.

2750 × Y = ^{DEG}
302'500.

Last Answer Memory ANS

ANS Recalls the last answer calculated by pressing =

<Example> Solve for x first and then solve for y using x.

$$x = \sqrt{2} + 3 \quad \text{and} \quad y = 4 \div x$$

Operation

2ndF $\sqrt{\quad}$ 2 + 3 =

Display

DEG

$\sqrt{2} + 3 =$
4.414213562



4 \div ALPHA ANS =

DEG

4 \div ANS =
0.906163678

Formula Memories



 ~  Formulas can be stored in F1 ~ F4.

<Example>

Calculates the volume of triangular pyramid by using a formula memory.

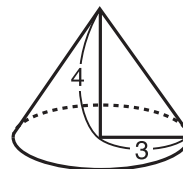

Operation



Display

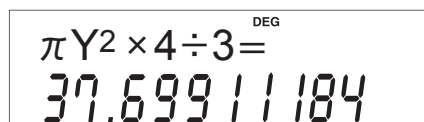
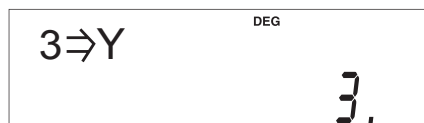
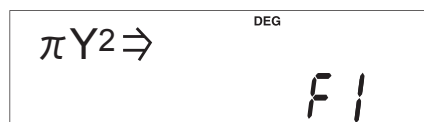

Trigonometric Functions

sin

cos

tan

Trigonometric functions determine the ratio of three sides of a right triangle. The combinations of the three sides are sin, cos, and tan. Their relations are:

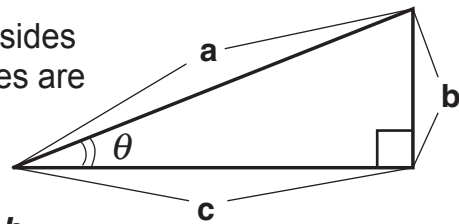

sin

Calculates the sine of an angle.

$$\sin \theta = \frac{b}{a}$$

cos

Calculates the cosine of an angle.

$$\cos \theta = \frac{c}{a}$$

tan

Calculates the tangent of an angle.

$$\tan \theta = \frac{b}{c}$$

<Example 1>

The angle from a point 15 meters from a building to the highest floor of the building is 45°. How tall is the building?

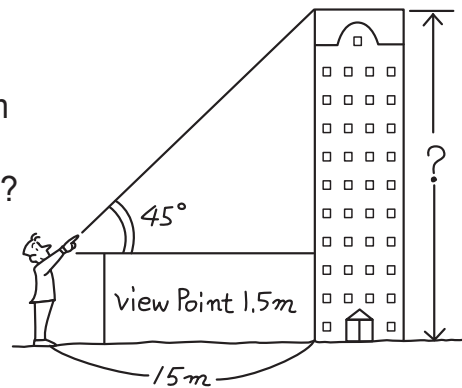

Operation

SET UP

0 (DRG)

0 (DEG)

<Angle setting "°" (DEG)>

tan

45 × 15

+ 1

• 5 =

View point

Display

DEG RAD^{DEG} GRAD
0 1 2

tan 45 × 15 + 1.5 →
16.5

APPLICATIONS:

Trigonometric functions are useful in mathematics and various engineering calculations. They are often used in astronomical observations, civil engineering and in calculations involving electrical circuits, as well as in calculations for physics such as parabolic motion and wave motion.

Trigonometric Functions

sin

cos

tan

<Example 2>

Find the length of the side of the following triangle.

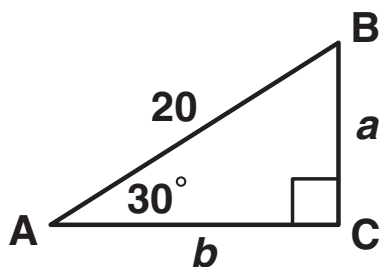

$$a = 20 \sin 30$$
$$b = 20 \cos 30$$

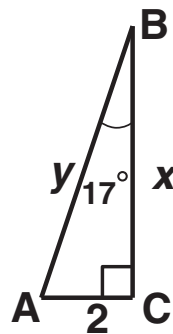

$$x = \frac{2}{\tan 17}$$
$$y = \frac{2}{\sin 17}$$

Operation

SET UP 0 (DRG)

0 (DEG)

<Angle setting "°" (DEG)>

Display

DEG	RAD	GRAD
0	1	2

Trigonometric Functions

sin

cos

tan

ON/C

$$20 \sin 30 =$$

$$20 \sin 30^{\text{DEG}} = 10.$$

$$20 \cos 30 =$$

$$20 \cos 30^{\text{DEG}} = 17.32050808$$

$$2 \text{ab/c} \tan 17 =$$

$$2 \text{r} \tan 17^{\text{DEG}} = 6.541705237$$

$$2 \text{ab/c} \sin 17 =$$

$$2 \text{r} \sin 17^{\text{DEG}} = 6.84060724$$

Arc Trigonometric Functions

Arc trigonometric functions, the inverse of trigonometric functions, are used to determine an angle from ratios of a right triangle.

The combinations of the three sides are \sin^{-1} , \cos^{-1} , and \tan^{-1} .

Their relations are;

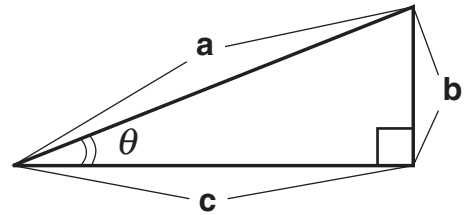

(arc sine) Determines an angle based on the ratio b/a of two sides of a right triangle.

$$\theta = \sin^{-1} \frac{b}{a}$$

(arc cosine) Determines an angle based on the ratio c/a for two sides of a right triangle.

$$\theta = \cos^{-1} \frac{c}{a}$$

(arc tangent) Determines an angle based on the ratio b/c for two sides of a right triangle.

$$\theta = \tan^{-1} \frac{b}{c}$$

<Example>

At what angle should an airplane climb in order to climb 80 meters in 100 meters?

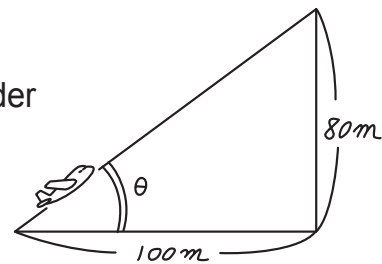

[DEG mode]

Operation

Display

$\tan^{-1}(80 \div 100)$ ^{DEG} →
 38.65980825

Hyperbolic Functions

hyp

arc hyp

hyp

The hyperbolic function is defined by using natural exponents in trigonometric functions.

arc hyp

Arc hyperbolic functions are defined by using natural logarithms in trigonometric functions.

APPLICATIONS:

Hyperbolic and arc hyperbolic functions are very useful in electrical engineering and physics.

Coordinate Conversion → $r\theta$ → xy , ←, →

→ $r\theta$ Converts rectangular coordinates to polar coordinates ($x, y \rightarrow r, \theta$)

→ xy Converts polar coordinates to rectangular coordinates ($r, \theta \rightarrow x, y$)

, Splits data used for dual-variable data input.

←, → Displays r, θ and x, y . ($x \rightleftharpoons y$ or $r \rightleftharpoons \theta$)

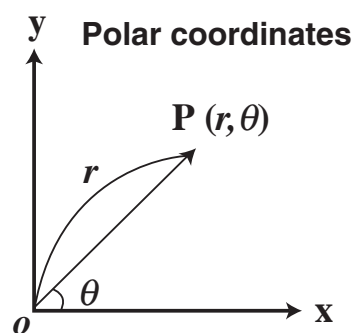
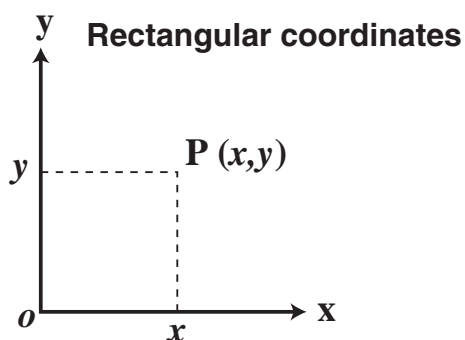

<Example> Determine the polar coordinates (r, θ) when the rectangular coordinates of Point P are ($x = 7, y = 3$).

[DEG mode]

<u>Operation</u>	<u>Display</u>
<p>7 2ndF , 3 2ndF →$r\theta$</p>	<div style="border: 1px solid black; padding: 5px; margin-bottom: 5px;"> <small>DEG</small> $r =$ 7.615773106 </div>
<p>2ndF ←, →</p>	<div style="border: 1px solid black; padding: 5px; margin-bottom: 5px;"> <small>DEG</small> $\theta =$ 23.19859051 </div>
<p>7.6 2ndF , 23.2</p>	<div style="border: 1px solid black; padding: 5px; margin-bottom: 5px;"> <small>DEG</small> $x =$ 6.985428578 </div>
<p>2ndF →xy</p>	<div style="border: 1px solid black; padding: 5px; margin-bottom: 5px;"> <small>DEG</small> $y =$ 2.993958513 </div>
<p>2ndF ←, →</p>	<div style="border: 1px solid black; padding: 5px; margin-bottom: 5px;"> <small>DEG</small> $x =$ 6.985428578 </div>
<p>2ndF ←, →</p>	<div style="border: 1px solid black; padding: 5px; margin-bottom: 5px;"> <small>DEG</small> $y =$ 2.993958513 </div>

APPLICATIONS:
 Coordinate conversion is often used in mathematics and engineering, especially for impedance calculations in electronics and electrical engineering.

Binary, Pental, Octal, Decimal, and Hexadecimal Operations (N-Base)

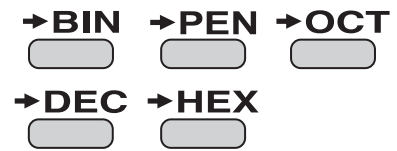

This calculator can perform conversions between numbers expressed in binary, pental, octal, decimal, and hexadecimal systems. It can also perform the four basic arithmetic operations, calculations with parentheses and memory calculations using binary, pental, octal, decimal, and hexadecimal numbers. In addition, the calculator can carry out the logical operations AND, OR, NOT, NEG, XOR, and XNOR on binary, pental, octal, and hexadecimal numbers.

- BIN** Converts to the binary system. "b" appears.
- PEN** Converts to the pental system. "P" appears.
- OCT** Converts to the octal system. "o" appears.
- HEX** Converts to the hexadecimal system. "H" appears.
- DEC** Converts to the decimal system. "b", "P", "o", and "H" disappear from the display.

Conversion is performed on the displayed value when these keys are pressed.

<Example 1> HEX(1AC) →BIN →PEN →OCT →DEC

<u>Operation</u>	<u>Display</u>
2ndF → HEX 1AC	DEG 1AC H
2ndF → BIN	DEG 1AC → BIN 110101100 b
2ndF → PEN	DEG 110101100 → PE 3203 P
2ndF → OCT	DEG 3203 → OCT 654 o
2ndF → DEC	DEG 654 → DEC 428

<Example 2> 1011 AND 101 = (BIN) →DEC

<u>Operation</u>	<u>Display</u>
ON/C 2ndF → BIN 1011 AND	DEG 1011 AND _ 0 b
101 =	DEG 1011 AND 101 = 1 b
2ndF → DEC	DEG 1 → DEC 1

Differentiation calculation

$\frac{d}{dx}$ x x^2

<Example>

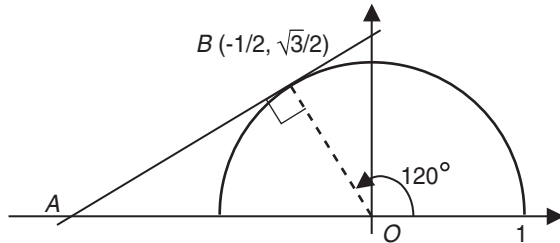

The semicircle above is given by the equation

$$y = \sqrt{1 - x^2}$$

Find the slope of the tangent AB at point $B (-1/2, \sqrt{3}/2)$ on the semicircle.

$$\left. \frac{d(\sqrt{1 - x^2})}{dx} \right|_{x = -\frac{1}{2}}$$

<u>Operation</u>		<u>Display</u>	
ON/C	2ndF $\sqrt{\quad}$	(
1	- ALPHA x		
x^2)		
2ndF $\frac{d}{dx}$	+/- 1		
ab/c	2	ENT	ENT

DEG
d/dx=
0.577350268

Integration calculation

$$\int dx \quad \underline{\quad}^x \quad x^2$$

<Example>

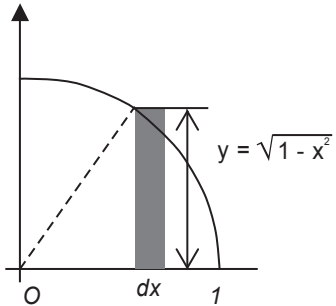

The fan shaped curve at left is given by the equation

$$y = \sqrt{1 - x^2}$$

Find the area of the fan shape with radius 1 and central angle 90° .

$$\int_0^1 \sqrt{1 - x^2} dx$$

Operation

Display

ON/C	2ndF	$\sqrt{\quad}$	(
1	-	ALPHA	x^2
x^2)		
$\int dx$	0	ENT	1
ENT	ENT		

DEG
$\int dx =$
0.785357562

Simulation Calculation

ALGB

<Example>

Solve for the length of hypotenuse C in a right triangle with a given length on each of the other two sides A and B.

The formula is;

$$C = \sqrt{A^2+B^2}$$

A=2, B=3, then C=?

A=2, B=5, then C=?

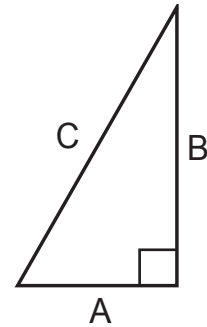

Operation

2ndF $\sqrt{\quad}$ (ALPHA α x^2

+ ALPHA α B x^2)

Enter the formula

2ndF ALGB 2 ENT 3 ENT

2ndF ALGB ENT 5 ENT

Display

$\sqrt{(A^2+B^2)^{\text{DEG}}}$ 0.

$\sqrt{(A^2+B^2)^{\text{DEG}}}$ = 3.605551275

$\sqrt{(A^2+B^2)^{\text{DEG}}}$ = 5.385164807

Statistics Functions

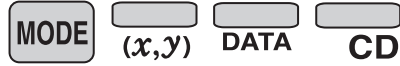

The statistics function is excellent for analyzing qualities of an event. Though primarily used for engineering and mathematics, the function is also applied to nearly all other fields including economics and medicine.

Splits data for input.

Enters data for statistical calculations.

Clears data input.

DATA INPUT FOR 1-VARIABLE STATISTICS

<Example 1> Here is a table of examination results. Input this data for analysis.

Data table 1

No.	1	2	3	4	5	6	7	8
Score	30	40	50	60	70	80	90	100
No. of pupils	2	4	5	7	12	10	8	2

Operation

Select single-variable statistics mode

30 2
⋮
100 2
Score (x) No. of pupils (Frequency)

Display

Stat 0 ^{DEG} ^{STAT}
0.

DATA SET= ^{DEG} ^{STAT}
1.

DATA SET= ^{DEG} ^{STAT}
8.

“ANS” KEYS FOR 1-VARIABLE STATISTICS

<input type="text" value="x̄"/>	Calculates the average value of the data (sample data x).
<input type="text" value="sx"/>	Calculates the standard deviation for the data (sample data x).
<input type="text" value="σx"/>	Calculates the standard deviation of a data population (sample data x).
<input type="text" value="n"/>	Displays the number of input data (sample data x).
<input type="text" value="Σx"/>	Calculates the sum of the data (sample data x).
<input type="text" value="Σx²"/>	Calculates the sum of the data (sample data x) raised to the second power.

NOTE:

1. Sample data refers to data selected randomly from the population.
2. Standard deviation of samples is determined by the sample data shift from an average value.
3. Standard deviation for the population is standard deviation when the sample data is deemed a population (full data).

Let's check the results based on the previous data.

<input type="text" value="RCL"/>	<input type="text" value="x̄"/>	69 (average value)
<input type="text" value="RCL"/>	<input type="text" value="sx"/>	17.75686128 (standard deviation)
<input type="text" value="RCL"/>	<input type="text" value="σx"/>	17.57839583 (standard deviation of the population)
<input type="text" value="RCL"/>	<input type="text" value="n"/>	50 (total count of data)
<input type="text" value="RCL"/>	<input type="text" value="Σx"/>	3450 (total)

DATA CORRECTION

Correction prior to pressing DATA immediately after a data entry: Delete incorrect data with ON/C , then enter the correct data.

Correction after pressing DATA :

Use \blacktriangle \blacktriangledown to display the data previously entered.

Press \blacktriangledown to display data items in ascending (oldest first) order. To reverse the display order to descending (latest first), press the \blacktriangle key. Each item is displayed with 'X:', 'Y:', or 'F:' (n is the sequential number of the data set).

Display the data item to modify, input the correct value, then press DATA . Using (x,y) , you can correct the values of the data set all at once.

- When \blacktriangle or \blacktriangledown appears, more data items can be browsed by pressing \blacktriangle or \blacktriangledown .
- To delete a data set, display an item of the data set to delete, then press 2ndF CD . The data set will be deleted.
- To add a new data set, press ON/C and input the values, then press DATA .

<Example 2>

Data table 2

X: 30, 40, 40, 50



X: 30, 45, 45, 45, 60

Operation

MODE 1 0

Select single-variable statistics mode

30 DATA

40 (x,y) 2 DATA

50 DATA

Display

Stat 0 DEG STAT
0.

DATA SET= DEG STAT
1.

DATA SET= DEG STAT
2.

DATA SET= DEG STAT
3.

Operation



45 3
(x,y) DATA



60
DATA

Display

↔X2= DEG STAT
40.

↔X2= DEG STAT
45.

↔N2= DEG STAT
3.

↔X3= DEG STAT
60.

APPLICATIONS:

Single-variable statistical calculations are used in a broad range of fields, including engineering, business, and economics. They are most often applied to analysis in atmospheric observations and physics experiments, as well as for quality control in factories.

DATA INPUT FOR 2-VARIABLE STATISTICS

<Example 3> The table below summarizes the dates in April when cherry blossoms bloom, and the average temperature for March in that same area. Determine basic statistical quantities for data X and data Y based on the data table.

Data table 3

	Year	2010	2011	2012	2013	2014	2015	2016	2017
x	Average temperature	6.2	7.0	6.8	8.7	7.9	6.5	6.1	8.2
y	Date blossoms bloom	13	9	11	5	7	12	15	7

Operation



Select dual-variable statistics mode and linear regression calculation in sub-mode.

6.2 13
(x,y) DATA
 ⋮
 ⋮
 ⋮

6.1 15
(x,y) DATA

8.2 7
(x,y) DATA

Display



“ANS” KEYS FOR 2-VARIABLE STATISTICS

In addition to the 1-variable statistic keys, the following keys have been added for calculating 2-variable statistics.

Σxy <input type="text"/>	Calculates the sum of the product for sample data x and sample data y .
Σy <input type="text"/>	Calculates the sum of the data (sample data y).
Σy^2 <input type="text"/>	Calculates the sum of the data (sample data y) raised to the second power.
\bar{y} <input type="text"/>	Calculates the average value of the data (sample data y).
sy <input type="text"/>	Calculates the standard deviation for the data (sample data y).
σy <input type="text"/>	Calculates the standard deviation of a data population (sample data y).

NOTE:

The codes for basic statistical quantities of sample data x and their meanings are the same as those for single-variable statistical calculations.

Let's check the results based on the previous data.

RCL <input type="text"/>	\bar{x}	7.175	(Average for data x)
RCL <input type="text"/>	sx	0.973579551	(Standard deviation for data x)
RCL <input type="text"/>	σx	0.91070028	(Standard deviation of the population for data x)
RCL <input type="text"/>	\bar{y}	9.875	(Average for data y)
RCL <input type="text"/>	sy	3.440826313	(Standard deviation for data y)
RCL <input type="text"/>	σy	3.218598297	(Standard deviation of the population for data y)
RCL <input type="text"/>	n	8	(Total count of data)
RCL <input type="text"/>	Σx	57.4	(Sum of data x)
RCL <input type="text"/>	Σx^2	418.48	(Sum of data x raised to the second power)
RCL <input type="text"/>	Σxy	544.1	(Sum of the product of data x and data y)
RCL <input type="text"/>	Σy	79	(Sum of data y)
RCL <input type="text"/>	Σy^2	863	(Sum of data y raised to the second power)

Simultaneous Calculation

MODE

<Example>

When ethanol C_2H_5OH is completely combusted, carbon dioxide CO_2 and water H_2O are created.

The chemical reaction formula of this reaction is expressed as follows:

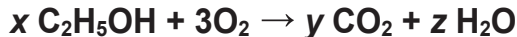

Find the values of x , y , and z to complete the chemical reaction formula.

The numbers of C, H, and O before and after the reaction are equal, hence

$$\text{Number of C: } 2x = y$$

$$\text{Number of H: } 5x + x = 2z$$

$$\text{Number of O: } x + 6 = 2y + z$$

As such, the following simultaneous equations are obtained:

$$2x - y + \quad = 0$$

$$6x \quad - 2z = 0$$

$$x - 2y - z = -6$$

Solving these gives

$$x = 1, y = 2, z = 3$$

and the chemical reaction formula is

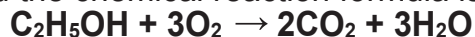

Operation

Display

Set the mode to Equation

MODE 2 (EQN)

2-VLE 3-VLE
0 1

<Equation mode>

1 (3-VLE)

<Simultaneous linear equations
in three unknowns>

a1? DEG 0.

Enter the coefficients

$$a1 = 2, b1 = -1, c1 = 0, d1 = 0$$

$$a2 = 6, b2 = 0, c2 = -2, d2 = 0$$

$$a3 = 1, b3 = -2, c3 = -1, d3 = -6$$

2 1 0 0

6 0 2 0

1 2 1 6

(x = 1)

(y = 2)

(z = 3)

Complex Calculation

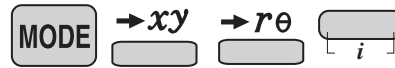

<Example>

An AC sine wave voltage of 100 V, 50 Hz is applied to a circuit consisting of a resistor ($R = 250\Omega$) and capacitor ($C = 20 \times 10^{-6}\text{F}$) connected in parallel. Find the impedance of this circuit.

Circuit impedance = Value of polar coordinate r

Let $R = 250$, $C = 20 \times 10^{-6}$, and $f = 50$.

If the complex number $Z = 1 \div ((1 \div R) + 2\pi fCi)$, find the value of the complex number Z and the values of r .

Operation	Display
MODE 3 (CPLX) Complex mode	
2ndF $\rightarrow xy$ (Rectangular coordinates)	
$1 \div ((1 \div 250) + 2 \times \pi \times 50 \times 20 \times 10^{-6} i)$	
2ndF \leftrightarrow	
SET UP 0 (DRG) 1 (RAD) <Angle setting RAD>	
2ndF $\rightarrow r\theta$ (Polar coordinates)	
2ndF \leftrightarrow	

SHARP
SHARP CORPORATION