

SHARP

Be Original.

MX-M1205
MX-M1055

Digital Multifunction System

Light Production Excellence
from a Truly Reliable Document Solution



Built for Dependable, High-Volume Perfo

Whether in a corporate data centre or a high-volume CRD*, Sharp's MX-M1205/M1055 stands out as a high-performance MFP you can count on. This light production powerhouse pumps out 120 or 105 ppm of pristine B/W documents in ultra-fine 1,200 dpi detail. Efficiency comes from duplex scanning and rock-solid paper-feeding technology that minimises misfeeds. And convenience comes from the Fiery® Server option and Command WorkStation® software, which let you manage print jobs right from the MFP's 15.4-inch colour touch panel. With its flexible configuration and range of finishing options, the MX-M1205/M1055 offers a walk-up-and-use solution for even the busiest print-on-demand environment.

* Central reprographics department

Saddle Stitch Finisher

Perfect for booklet making, this option automatically staples, punches holes*, and folds. With the addition of the optional Trimming Module, the edges of saddle-stitched documents can be trimmed to a beautifully consistent finish. Two optional Finishers are available to meet your application.

* Requires separate Punch Module option.

Inserter

Thanks to two 200-sheet input trays that can handle different types of paper, the optional Inserter can add pre-printed covers and coloured pages to give documents a high-grade, professional look.

Duplex Single Pass Feeder

Because this highly reliable document feeder scans both sides of two-sided originals in one pass, large-volume documents can be scanned quickly and efficiently.

Folding Unit

This option performs five types of automated folding—z-fold, c-fold, accordion fold, double fold, and half-fold—for efficient production of direct mail and other items.

Stackers

Optional 5,000-sheet High Capacity Stackers with roll-out carts can be connected in tandem for unattended output of up to 10,000 sheets.

Curl Correction Unit

To ensure smooth paper transport, top and bottom rollers on this optional unit keep paper from warping.



Performance

Productivity



Reliability



Usability



Status Indicator

The optional Status Indicator provides status alerts, including notice of errors, via green and red LED lights that can easily be seen from a distance.

15.4-Inch Colour Touchscreen LCD

A user-friendly touchscreen interface enables intuitive MFP operation. Document finishes and page layout can be confirmed onscreen before printing to prevent erroneous printouts and paper waste. And documents can be previewed in various modes to match the task at hand.

QWERTY Keyboard

Adding the full-size QWERTY keyboard option makes it easy to type in any needed information.

Multi Bypass Tray

This option can feed in up to 500 sheets.

Large Capacity Trays

Adding two 5,000-sheet Large Capacity Trays and a Multi Bypass Tray expands the standard 3,100-sheet paper capacity to 13,500 sheets.

Fiery Server

This optional server, the de facto industry standard, turns the MX-M1205/M1055 into a powerful centralised solution for high-demand print environments. Its user-friendly Command WorkStation software enables easy job management right from the MFP's touchscreen LCD.



A Heavy-Duty Productivity Booster

A Winning Combination of Speed and Power

Built to meet the rigorous, high-volume demands of offices, copy rooms, CRD, and corporate data centers, the MX-M1205/M1055 delivers B/W copying and printing at the impressive speed of **120/105 ppm**. Advanced technology, integrated network scanning, and flexible configurations expedite job processing and streamline document workflow like never before. And to bring productivity and reliability where it's needed most, this high-volume workhorse boasts a 1TB hard drive and 5GB of standard memory.

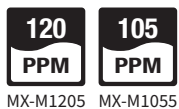

High-Efficiency Scanning

The MX-M1205/M1055 can scan both pages of two-sided B/W and colour documents in one efficient pass. Capable of scanning one-sided A4-size (8 1/2" x 11") documents at **120 opm*** and two-sided A4 documents at **200 opm***, the **250-sheet DSPF** (duplex single pass feeder) minimises paper misfeeds and brings fast, reliable operation.

* Originals per minute (when feeding A4-size documents at 200 dpi resolution)



Large Paper Capacity

While the MX-M1205/M1055 holds a generous 3,100 sheets of paper, this standard capacity can be expanded to meet the needs of high-volume jobs. Adding an optional 500-sheet Multi Bypass Tray and two 5,000-sheet (2,500 x 2) Large Capacity Trays boosts capacity to **13,500 sheets**. And when a tray runs out of paper, the **Auto Tray Switching** function automatically switches to another tray with the same-sized paper.

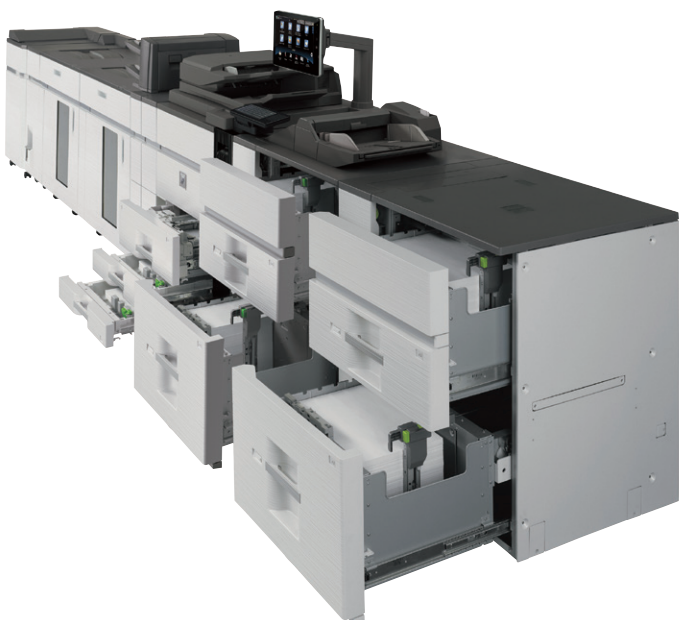

Paper Setting Registration

The MX-M1205/M1055's Paper Setting Registration function allows instant recall of pre-registered media profiles. It stores up to **1,000 media profiles** that include front-to-back registration settings (see page 5), data on fusing temperature, and data on the type and weight of paper used. This allows identical, frequently executed jobs to be performed without the need to set the MFP each time, thereby helping to save time and ensure consistency from job to job.

Status Indicator

The optional Status Indicator provides diagnostics via green and red LED lights that are clearly visible from a distance. The green light remains lit while a job is being executed and blinks while document data is being read. The red light blinks or lights up to indicate an error that may or may not prevent normal operation.

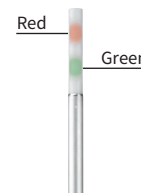

Document Management on the Hard Disk

To boost information sharing and distribution, processed job data can be saved in designated folders on the MX-M1205/M1055's built-in hard disk for instant recall, printing, or sending at a later time. Data for frequently used template documents can also be saved on the hard disk, enabling quick and easy output for enhanced productivity.

Network Tandem Output

When two MX-M1205/M1055s are connected to the same office network, they can be used simultaneously to double copy/print output to up to **240 ppm**. Large-volume jobs can be completed with ease, ensuring that tight deadlines will be met.

High Capacity Stacker

With an optional High Capacity Stacker, the MX-M1205/M1055 can accommodate up to 5,000 sheets, expandable to **10,000 sheets** when two stackers are connected. Each stacker comes with a roll-out **Paper Cart** for effortless and efficient transport.



Intermediate Toner Hopper for Continuous Runs

Thanks to an intermediate toner hopper, there's no need to stop the MX-M1205/M1055 during large-volume copy/print jobs when the toner cartridge needs changing. The MX-M1205/M1055 can use toner from the toner hopper to continue printing while the empty toner cartridge is replaced with a new one.



Printing continues during toner cartridge replacement

Flexibility in Paper Handling and Finishing Options

Versatile Paper Handling

The MX-M1205/M1055 accommodates a wide variety of paper sizes and weights, expanding the range of possible printing applications.

- **Paper Sizes:** The MX-M1205/M1055 supports an extensive range of standard paper sizes from A5 to SRA3/A3 wide (5 1/2" × 8 1/2" to 12" × 18").
- **Paper Weights:** The MX-M1205/M1055 handles paper as thin as 52 g/m² and as thick as **300 g/m²**. Duplexing is possible for paper ranging from 60 g/m² to 220 g/m².



Professional-Quality In-Line Finishing Options

Stapling and Punching

With a maximum output capacity of 4,250 sheets, handy Finishers provide three stapling positions—front corner, rear corner, and two-point side—for up to 100 sheets (MX-FN21/FN22) per set. Two-to-four-hole punching is available as an option.

• Stapling Positions

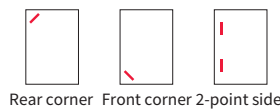

• Punching Positions

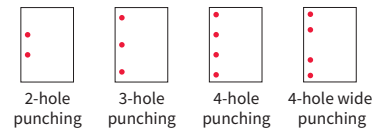

Saddle Stitching

In addition to conventional stapling, the MX-FN22 Saddle Stitch Finisher can staple and fold sets of documents up to 20 sheets.

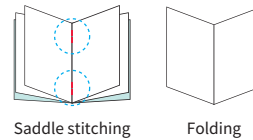

Trimming

For professional-looking booklets, Saddle Stitch Finishers can be equipped with a Trimming Module that gives the edges of saddle-stitched documents a beautifully consistent finish.

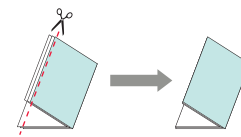

A Variety of Folds

The MX-M1205/M1055 automates various types of folding, such as z-folding and c-folding, for efficient production of direct mail, brochures, and more.

*1: For A3- and A4-size (short-edge feed) paper.

*2: Z-fold and half-fold pages are ejected from the finisher (MX-FN22/FN21).

*3: For A4-size (short-edge feed) paper.

*4: For A3 wide-, A3-, and A4-size (short-edge feed) paper.

• Fold Variations

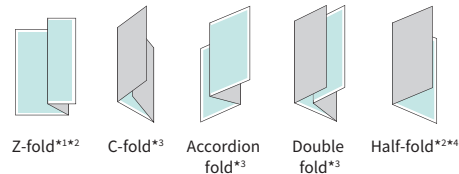

MX-FD10 Folding Unit

Insertion

For truly professional results, the Inserter can add pre-printed covers and insert paper up to 220 g/m² to documents before final finishing. Two input trays, each with a capacity of 200 sheets, make it possible to feed in two different types of paper.

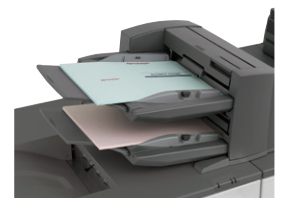
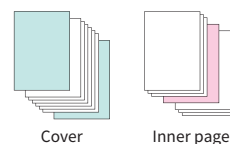

Reliability Builders

Triple Air-Feed System

The Triple Air-Feed System on the optional 5,000-sheet MX-LC13 N Large Capacity Trays reliably separates and feeds in paper to facilitate jam-free operation and minimise downtime. Capable of supporting a wide range of paper types, this system employs air-feed technology and three precisely directed air flows for maximum reliability and proper paper handling.

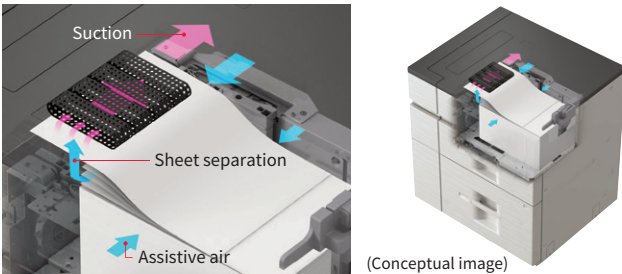

Multi-Feed Detection System

A precision-engineered Multi-Feed Detection System on the MX-M1205/M1055 employs ultrasonic technology to detect misfeeds in the 250-sheet DSPF and the paper feed section of the paper trays.

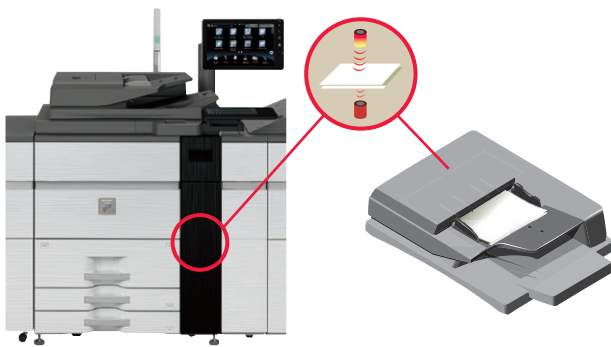

Curl Correction

For reliable output of two-sided copies and prints, the MX-M1205/M1055 provides built-in curl correction to uncurl paper just after transfer. And for added stability, the optional Curl Correction Unit uses top and bottom rollers to apply pressure to convex and concave curls, preventing paper from warping before it goes to the finisher.

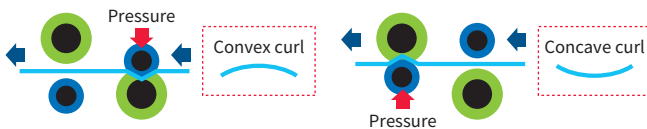

Full Front Access

Particularly convenient during toner cartridge replacement, an unlikely paper jam, and other operations, full front access to all key machine components ensures easy maintenance—and maximum uptime.



Developer Cooling Systems

The developer unit in the MX-M1205/M1055 employs a forced-air cooling system to prevent excessive heat build-up. This enables the unit to maintain consistent image quality, even in high-volume printing environments.



Highly Rigid Main Frame

A highly rigid support frame isolates and protects critical machine components in the MX-M1205/M1055, ensuring increased durability and reliability. The unit can withstand heavy use in locations where rapid, high-volume output is demanded.

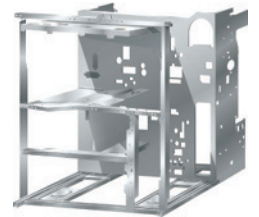

Mirroring Kit

To protect the MX-M1205/M1055's enhanced data-handling capability and bring peace of mind, the optional Mirroring Kit provides hard disk backup. In the event that one hard disk is damaged, the data will be saved safely on another disk, ensuring continued operation.

Administrator Machine Adjustments

The MX-M1205/M1055 has a machine adjustment menu to enable MFP administrators (i.e., trained print room managers) to access and configure machine set-up for a total of 40 items in three areas: image quality, image position/ratio/area, and peripherals. As there is no need to call for outside service staff when making MFP adjustments, machine downtime is reduced and productivity boosted.



Front-to-Back Registration

Based on feedback from two paper-position sensors located in the paper path, the MX-M1205/M1055 employs an image shift function to automatically adjust the position of printed images with respect to the edges of a page. This precise front-to-back registration ensures exact correspondence of the printed material, so that consistently high levels of quality can be achieved when producing leaflets, brochures, and other documents—including those with two-sided double-page spreads or those that are to be saddle stitched and trimmed. Users can also manually adjust vertical/horizontal ratio and position settings to achieve even more precise front-to-back registration.

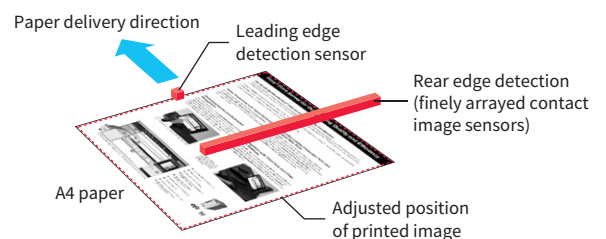

Fiery Server for Outstanding Quality and Efficiency

MX-M1205/M1055 and Fiery Server—A Winning Combination

Paired with the MX-PE11, an industry-leading EFI™ Fiery external server, the Sharp MX-M1205/M1055 becomes a powerful integrated solution for managing professional in-plant and busy on-demand printing environments. This winning combination offers the following benefits, to name just a few:

- Easily manage jobs with Fiery Command WorkStation fully integrated at the MX-M1205/M1055's touchscreen for unmatched control and ease of use.
- Deliver high-impact documents that maintain consistent results page after page.
- Process large, complex jobs at speeds of 120/105 ppm that will exceed your expectations.

High Productivity with Superb Performance

The powerful architecture of the MX-PE11 Fiery Server shortens turnaround times, while helping companies produce professional-looking finished jobs that win them new business and get their customers noticed.

Centralised Control and Automated Management

The MX-PE11 Fiery Server offers a centralised solution that features the award-winning Command WorkStation with a de facto industry-standard print job management user interface. Its interactive WYSIWYG interface enables operators to monitor, control, and troubleshoot production from multiple desktops or locally at the Fiery Server directly from the MX-M1205/M1055's touchscreen.



Command WorkStation is fully integrated at the Sharp control panel

Industry-Leading Production Print and Variable Data Tools

The MX-PE11 Fiery Server offers optional make-ready tools and driver-based imposition with the optional saddle stitch finisher to efficiently handle many production processes. The MX-PE11 Fiery Server enables customers to produce short-run jobs profitably by automating manual tasks, and increases workflow flexibility by supporting industry-leading variable data printing (VDP) formats including PPML and the new PDF/VT-1 and 2 formats.

Integration with Third-Party and Other EFI Solutions

The MX-PE11 Fiery Server uses the Adobe PDF Print Engine (APPE) v2.5 rendering technology to offer a native end-to-end PDF workflow. The Fiery open platform also supports industry standards and seamlessly integrates with existing MIS environments, third-party vendors, and other EFI MIS solutions.



An optional keyboard allows easy data and text entry, and an optional touch pad (part of the MX-PX11 Fiery Interface Kit) allows you to control an on-screen mouse

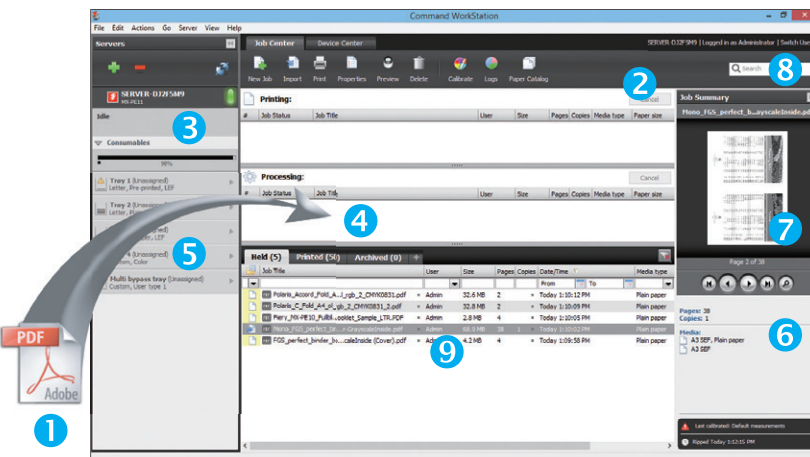

The Job Center is the operator's main interface for all job management and set-up controls for Fiery servers

- 1 Drag & drop capabilities for fewer clicks
- 2 Customisable tool bar
- 3 Instant status of all Fiery servers
- 4 Job grouping for efficient job management and visibility of job status
- 5 Instant information on engine, consumables, and media
- 6 Instant information on job requirements
- 7 Integrated job preview
- 8 Integrated job search across all Fiery servers
- 9 Inline editing of number of copies, job name, and workflow



Exceptional Ease of Use

15.4-Inch Colour Touchscreen LCD

MFP operation has never been so intuitive, so easy. The control panel on the MX-M1205/M1055 features a clear, wide WXGA touchscreen LCD, ensuring that simple hand gestures applied to the screen bring effortless control of every document, function, and setting. With its user-friendly operation and easy customisation, this high-resolution touchscreen boosts productivity to the next level. For easy viewing, the control panel can be tilted from front to back and from side to side, and the arm, to which the control panel is attached, can be freely rotated from side to side to the user's desired angle.

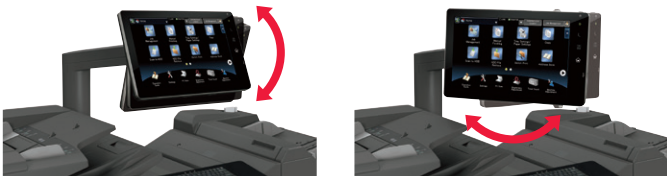

Advanced Preview

The Advanced Preview function saves you time and effort by showing scanned images on the LCD as thumbnail displays for easy confirmation and editing. Page layout, stapling, and other aspects of document finishing can be checked before documents are printed out. Pages can be previewed in 3D, rotated, put in a different order, or deleted via touch-and-drag editing on the LCD. You can even erase specific pages and insert blank pages.



Job Management

The MX-M1205/M1055 features a Job Management screen that allows users to oversee their print jobs and have complete control of them. From here, users can easily view the status of individual jobs, change the order of jobs in the print queue, and quickly retrieve files from the MFP's hard disk. The Job Management screen also shows the scheduled start time of jobs later in the print queue, so that users can know how long the current job will take. This helps users prioritise their workload and ensures maximum productivity.



QWERTY Keyboard (option)

Convenient for typing e-mail addresses and messages, as well as passwords for user authentication, this full-size QWERTY keyboard makes text input fast and easy.



Remarkable Image Quality

Mycrostoner-EP

Sharp's proprietary Mycrostoner-EP (Eco-Positive) ensures optimum density and edge definition for the superb reproduction of fine lines and halftones. And while Mycrostoner-EP enables high-quality printing of photographs and illustrations, it also maximises toner yield and minimises waste.

High-Resolution Output

The MX-M1205/M1055 delivers razor-sharp **1,200 dpi** copying and printing (600 dpi at default setting)—without sacrificing output speed. Fine-grained photographs, detailed illustrations and graphs, and small text all come out crisp and clear.

Halftone Process Control

Halftone process control brings optimal monochrome gradation and outstanding image quality to high-volume copy/print jobs. Employing an image density sensor to enhance the stability and accuracy of each gradation, halftone process control ensures consistently high image quality from first page to last.

Enhanced Scan Performance

Background Suppression

A function of Auto Colour Mode, the automatic suppression of unnecessary background colour is essential to achieving crisp, clear, natural-looking images. The MX-M1205/M1055 provides enhanced background suppression without losing colour balance, resulting in scanned images that closely match the original.

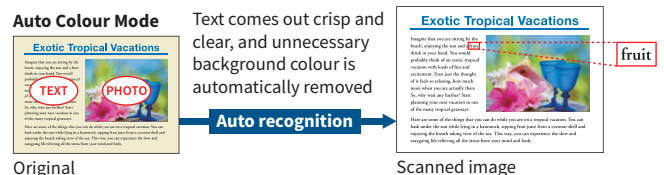

Colour Reproduction

Enhanced scan performance improves the legibility of extremely fine text and allows natural colour reproduction in scanned documents. Even delicate human skin tones can be reproduced naturally, without excessive colouration.

Data Encryption and Overwriting

MFPs retain large amounts of data generated from copy/print/scan jobs in internal storage. To safeguard confidential data from unauthorised access, standard-equipped security features on the MX-M1205/M1055 automatically **encrypt** job data prior to saving it to internal storage. Once a job is finished, that encrypted data is **erased** via up to seven automatic overwrites. Protection of administrator/file/folder passwords brings further peace of mind.

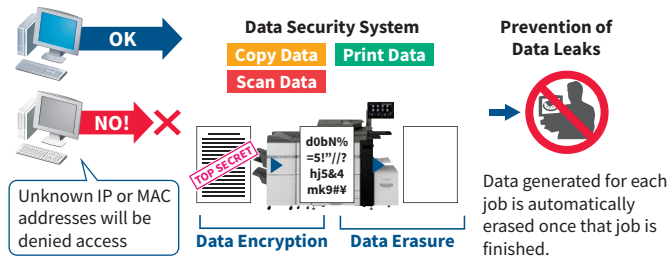

Note: Contact a Sharp customer representative for details on activating this function.

User Authentication

The MX-M1205/M1055 prevents unauthorised use by requiring **passwords** for machine access. This safeguarded solution can register up to 1,000 users in **three access levels** as Administrator, User, or Guest and can designate to which function user authentication applies. And the MX-M1205/M1055 works with an **external Active Directory® server** to extend user authentication to multiple MFPs and a greater number of users.

Eco-Friendly Advances

Low Power Consumption

To reduce power consumption, Sharp has applied its advanced technologies across all areas of this MFP, including the hardware, software, electrical system, and supplies. As a result, the MX-M1205/M1055 delivers exceptional energy efficiency.

LED Lamps

Energy-efficient LED lamps employed in the scan unit (instead of conventional xenon lamps) provide further energy savings.

Auto Power Shut-Off Mode

Based on usage patterns established over a four-week period, Auto Power Shut-Off mode automatically determines the optimal length of time to let elapse before turning the power off. To accommodate intensive use of the MFP on a specific day or time, users can manually set the elapse time to suit their specific usage patterns.

Document Control*

The Document Control function prevents unauthorised copying, scanning, and filing of confidential documents by embedding copy prevention data onto a document. When that data is detected, any unauthorised attempts to copy are cancelled or result in only blank-page output.

* Requires optional MX-FR53U. May not work with certain types of paper, documents (such as those with a large volume of photos), or MFP settings.

Tracking and Auditing Information

Sharp offers both built-in and additional hardware/firmware systems that allow users to control, access, and track usage of each device on the network.

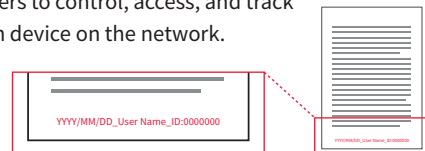

Hidden Pattern Copy/Print

With this function, a watermark, such as "Confidential" or "Not for Copy," can be embedded onto a document. If that document is copied, the watermark will appear, alerting the user not to distribute it.

Other Key Features

- Supports the IEEE 802.1X standard for port-based network access control and the IEEE 2600 standard for hardcopy device and system security
- IP/MAC address filtering restricts unauthorised access
- SSL and IPsec enable data encryption for secure network communications
- Retained data can be initialised when it's time to replace the MFP
- Encrypted PDF secures a document by scanning it into a password-protected PDF for transmission over the network in encrypted format

Power ON/OFF Scheduling

The Power ON/OFF Schedule function automatically turns the MX-M1205/M1055 on or off according to time schedules set by the administrator.

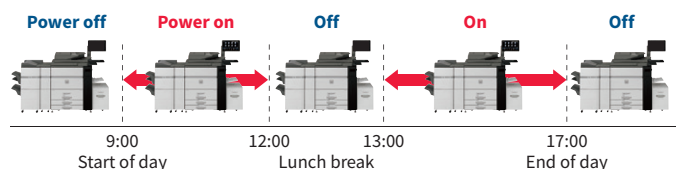

Eco Scan

Eco Scan function saves energy by turning off power to the fusing system during jobs that don't require any printing, such as scanning and Document Filing.

Biomass Plastic and Toner

The MX-M1205/M1055's use of carbon-neutral biomass plastic and toner makes it an exceptionally environment-friendly MFP. Employing biomass materials helps reduce CO₂ emissions and lessens environmental impact.

Working with Applications

Device Management

Web-Based System Settings

Administrators can manage user access and security settings as well as other controls and configurations right from their desktops through a standard Web browser.

Network Utility Software

Sharp Remote Device Manager* (SRDM) gives administrators centralised control of their networked MFPs through a standard web browser, making device cloning and other operations easier and more accessible.

* Contact a Sharp customer representative for availability and other details.

Remote Operation

The Remote Operation function lets you display the MFP's main control panel on your PC screen, allowing you to operate every major function directly from your desktop*. This function also enables the administrator to remotely guide an MFP user through necessary procedures.

* Requires VNC application.

Sharp OSA*

As an innovative development platform, Sharp OSA (Open Systems Architecture) allows you to interact with critical business and network applications—or access an external accounting module—right from the touchscreen LCD control panel, bringing a whole new realm of control and convenience. And since Sharp OSA utilises industry-standard network protocols, the MX-M1205/M1055 can easily integrate with document management systems, software for enterprise resource planning, workflow applications, and more. The latest version of Sharp OSA can reach beyond the firewall, enabling extensive system construction and services over the Internet. Other benefits of bringing Sharp OSA on board include the reduction of costs associated with system implementation and management and the ability to share data across company branch offices or subsidiaries.

* Requires optional MX-AMX2 and/or MX-AMX3.

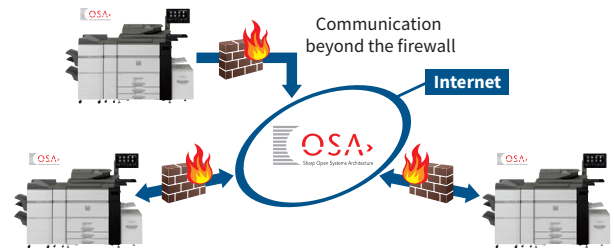

System Configuration

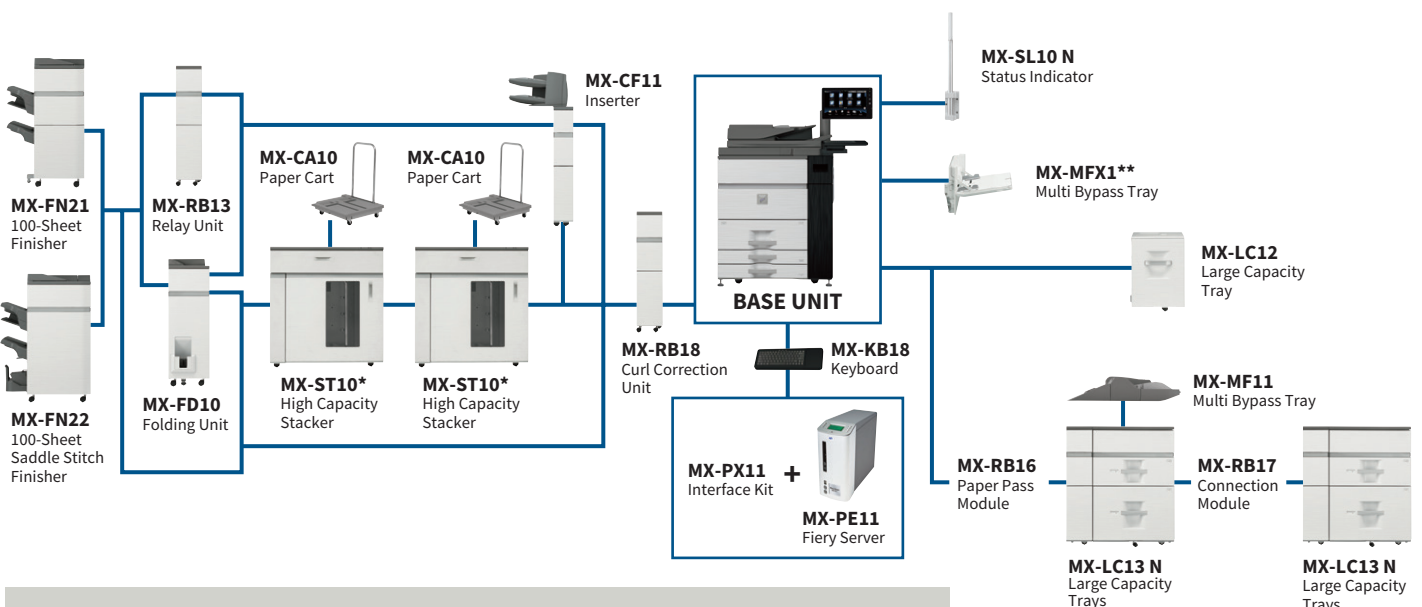

MX-PN13A/B/C/D Punch Module (for MX-FN21/22)	MX-AM10 Web Browsing Expansion Kit	MX-AMX3 External Account Module
MX-TM10 Trimming Module (for MX-FN22)	AR-SU1 Stamp Unit	MX-EB11 Enhanced Compression Kit
MX-PUX1 XPS Expansion Kit	MX-AMX1 Application Integration Module	MX-EB15 Mirroring Kit
MX-PF10 Barcode Font Kit	MX-AMX2 Application Communication Module	MX-FR53U Data Security Kit

* Up to two Stacker can be connected for use together.
MX-ST10 comes standard with one MX-CA10.
** Minimum required equipment.

Certain optional equipment may not be available in some areas.

Specifications for Optional Equipment

MX-FN21 Finisher

Paper size	Non offset Offset/staple	SRA3/A3 wide (12" x 18") to A5 (5 1/2" x 8 1/2")* ¹ A3 (11" x 17") to B5* ² (8 1/2" x 11")
Paper weight	Non offset/offset Staple	52 g/m ² to 300 g/m ² (13 lbs bond to 110 lbs cover) 60 g/m ² to 300 g/m ² (16 lbs bond to 110 lbs cover)
Paper capacity (80 g/m ²)	Upper tray Lower tray Middle tray	1,500 sheets (up to A4), 750 sheets (up to SRA3) 2,500 sheets (up to A4), 750 sheets (up to SRA3) 250 sheets (up to A4), 125 sheets (up to A3), 30 sheets (up to SRA3)
Stapling capacity* ³		100 sheets (A4, B5), 50 sheets (A3, B4, A4* ⁴)
Staple position		3 locations (front, rear, 2 staples)
Power consumption (max.)		200 W, 350 W with MX-FD10
Power requirements		230V, 10A
Dimensions	With tray stored With tray extended	654 x 765 x 1,040 mm (W x D x H) 782 x 765 x 1,040 mm (W x D x H)
Weight		61 kg

MX-FN22 Saddle Stitch Finisher

Paper size	Non offset Offset/staple	SRA3/A3 wide (12" x 18") to A5 (5 1/2" x 8 1/2")* ¹ A3 (11" x 17") to B5* ² (8 1/2" x 11")
Paper weight	Non offset/offset Staple/booklet Folding	52 g/m ² to 300 g/m ² (13 lbs bond to 110 lbs cover) 60 g/m ² to 300 g/m ² (16 lbs bond to 110 lbs cover) 60 g/m ² to 220 g/m ² (16 lbs bond to 80 lbs cover)
Paper capacity (80 g/m ²)	Upper tray Lower tray Middle tray Saddle stitch tray	1,500 sheets (up to A4), 750 sheets (up to SRA3) 2,500 sheets (up to A4), 750 sheets (up to SRA3) 250 sheets (up to A4), 125 sheets (up to A3), 30 sheets (up to SRA3) 1–5 sheets: 25 sets, 6–10 sheets: 15 sets, 11–15 sheets: 10 sets, 16–20 sheets: 5 sets
Stapling capacity* ³		100 sheets (A4, B5), 50 sheets (A3, B4, A4* ⁴)
Staple position		3 locations (front, rear, 2 staples)
Power consumption (max.)		200 W, 350 W with MX-FD10
Power requirements		230V, 10A
Dimensions	With tray stored With tray extended	767 x 765 x 1,040 mm (W x D x H) 896 x 765 x 1,040 mm (W x D x H)
Weight		108 kg

Punch Modules

Model name	For the MX-FN21/22	MX-PN13A	MX-PN13B	MX-PN13C	MX-PN13D
Number of holes		2	3/2	4/2	4 (wide)
Paper weight		52 g/m ² to 256 g/m ²			
Power requirements		Powered by MX-FN21/FN22 Finisher			

MX-TM10 Trimming Module (for MX-FN22)

Paper size	SRA3/A3 wide (12" x 18") to A4 (8 1/2" x 11")* ⁴
Paper weight	60 g/m ² to 300 g/m ² (16 lbs bond to 110 lbs cover)
Acceptable number of sheets* ⁵	2–20 sheets (60 g/m ² to 81.4 g/m ²), 2–10 sheets (more than 81.4 g/m ² to 105 g/m ²), 2–3 sheets (more than 105 g/m ² to 220 g/m ²)
Trim width	2 mm to 20 mm in 0.1 mm increments
Power requirements	Powered by MX-FN22 Finisher
Dimensions	251 x 625 x 403 mm (W x D x H)
Weight	32 kg

MX-ST10 Stacker

Paper size	Top tray Stacking tray	SRA3/A3 wide (12" x 18") to A5 (5 1/2" x 8 1/2")* ¹ SRA3/A3 wide (12" x 18") to A5 (5 1/2" x 8 1/2")* ¹
Paper capacity (80 g/m ²)	Top tray Stacking tray	250 sheets 5,000 sheets (up to A3 wide), 2,500 sheets (up to B5)
Paper weight		52 g/m ² to 300 g/m ² (13 lbs bond to 110 lbs cover)
Power consumption (max.)		Standby mode: 24 W In operation: 81 W
Power requirements		100V to 240V, 50/60Hz
Dimensions	Main unit Cart	915 x 758 x 986 mm (W x D x H) 592 x 531 x 750 mm (W x D x H)
Weight	Main unit Cart	100 kg 15 kg

MX-FD10 Folding Unit

Folding mode	Z-fold, C-fold, Accordion-fold, Double-fold, Half-fold	
Paper size	Z-/Half-fold* ⁶ C-/Accordion-/Double-fold	A3 (11" x 17") to A4 (8 1/2" x 11")* ⁴ A4 (8 1/2" x 11")* ⁴
Paper capacity (80 g/m ²)	Z-fold* ⁶ Half-fold* ⁶ C-/Accordion-fold Double-fold	30 sheets (up to A3), 10 sheets (A4) 10 sheets (A4) 40 sheets (A4) 25 sheets (A4)
Paper weight		52 g/m ² to 105 g/m ² (13 lbs bond to 28 lbs bond)
Power requirements		Powered by MX-FN21/FN22 Finisher
Dimensions		336 x 793 x 1,050 mm (W x D x H)
Weight		66 kg

MX-RB18 Curl Correction Unit

Paper size	SRA3/A3 wide (12" x 18") to A5 (5 1/2" x 8 1/2")* ¹
Paper weight	52 g/m ² to 300 g/m ² (13 lbs bond to 110 lbs cover)
Power requirements	Supplied by main unit
Dimensions	214 x 760 x 986 mm (W x D x H)
Weight	18.5 kg or less

MX-CF11 Inserter

Paper size	SRA3/A3 wide (12" x 18") to A5 (5 1/2" x 8 1/2")* ¹	
Paper weight	60 g/m ² to 220 g/m ² (16 lbs bond to 80 lbs cover)	
Paper capacity (80 g/m ²)	Upper/lower tray	200 sheets/each
Power requirements		Supplied by main unit
Dimensions	With tray stored With tray extended	540 x 760 x 1,276 mm (W x D x H) 690 x 760 x 1,276 mm (W x D x H)
Weight		45 kg

MX-LC12 Large Capacity Tray

Paper size	A4, B5 (8 1/2" x 11")* ⁷
Paper weight	60 g/m ² to 220 g/m ² (16 lbs bond to 80 lbs cover)
Paper capacity (80 g/m ²)	3,500 sheets
Power requirements	Supplied by main unit
Dimensions	376 x 576 x 524 mm (W x D x H)
Weight	28.5 kg

MX-LC13 N Large Capacity Trays

Paper size	SRA3/A3 wide (12" x 18") to B5 (7 1/4" x 10 1/2")* ⁸	
Paper weight	52 g/m ² to 300 g/m ² (13 lbs bond to 110 lbs cover)	
Paper capacity (80 g/m ²)	Upper/lower tray	2,500 sheets/each
Power consumption		900 W
Power requirements (max.)		230V, 10A
Dimensions		895 x 763 x 986 mm (W x D x H)
Weight		131 kg

MX-MFX1 Multi Bypass Tray

Paper size	A3 wide (12" x 18") to A5 (5 1/2" x 8 1/2")* ¹	
Paper weight	52 g/m ² to 300 g/m ² (13 lbs bond to 110 lbs cover)	
Paper capacity (80 g/m ²)	100 sheets	
Power requirements	Supplied by main unit	
Dimensions	With tray stored With tray extended	117 x 507 x 409 mm (W x D x H) 373 x 507 x 409 mm (W x D x H)
Weight		7.5 kg

MX-MF11 Multi Bypass Tray (for MX-LC13 N)

Paper size	SRA3/A3 wide (12" x 18") to A5 (5 1/2" x 8 1/2")* ¹	
Paper weight	52 g/m ² to 220 g/m ² (13 lbs bond to 80 lbs cover)	
Paper capacity (80 g/m ²)	500 sheets	
Power requirements	Powered by MX-LC13 N Large Capacity Trays	
Dimensions	With tray stored With tray extended	705 x 556 x 203 mm (W x D x H) 878 x 556 x 203 mm (W x D x H)
Weight		18 kg

*1 Only short-edge feeding can be used with A5 (5 1/2" x 8 1/2") paper.

*2 Only long-edge feeding can be used with B5 paper.

*3 Using 80 g/m² paper, can include back and front covers (total of 2 sheets) of heaviest paper that can be stapled.

*4 Only short-edge feeding can be used with A4 (8 1/2" x 11") paper.

*5 Can include a single cover sheet of 300 g/m² or less.

*6 Z-fold and half-fold pages are ejected from the finisher (MX-FN21/FN22).

*7 Only long-edge feeding can be used with A4 and B5 (8 1/2" x 11") paper.

*8 Only short-edge feeding can be used with 7 1/4" x 10 1/2" paper.

SPECIFICATIONS (tentative)

General

Type	Console
Engine speed	A4 (8 1/2" x 11")*1: Max. 120/105 ppm A3 (11" x 17"): Max. 54/52 ppm SRA3: Max. 52/49 ppm
Control panel display	15.4-inch colour LCD touchscreen
Paper size	Max. SRA3/A3 wide (12" x 18"), min. A5 (5 1/2" x 8 1/2")*2
Paper capacity (80 g/m ²)	Standard: 3,100 sheets*3 (1,200-sheet tray, 800-sheet tray, 500-sheet tray x 2, and optional 100-sheet multi-bypass tray) Maximum: 13,500 sheets (3,000 sheets & optional 2x 2,500-sheet tray x 2 and 500-sheet multi-bypass tray)
Paper weight	Tray 1&2: 60 g/m ² to 105 g/m ² (16 lbs bond to 28 lbs bond) Tray 3&4: 60 g/m ² to 220 g/m ² (16 lbs bond to 80 lbs cover) Multi-bypass tray (MX-MFX1): 52 g/m ² to 300 g/m ² (13 lbs bond to 110 lbs cover) Multi-bypass tray (MX-MF11): 52 g/m ² to 220 g/m ² (13 lbs bond to 80 lbs cover) Large capacity tray (MX-LC12): 60 g/m ² to 220 g/m ² (16 lbs bond to 80 lbs cover) Large capacity trays (MX-LC13 N): 52 g/m ² to 300 g/m ² (13 lbs bond to 110 lbs cover)
Warm-up time**4	210 sec.
Memory	5 GB (copy/print shared) 1 TB HDD*5
Power requirements	220 V to 240 V, 13 A, 50/60 Hz
Power consumption	Max. 2.99 kW
Dimensions (W x D x H)	1,099 x 775 x 1,529 mm (43 9/32" x 30 33/64" x 60 13/64")
Weight (approx.)	300 kg (661.4 lbs)

Copier

Original paper size	Max. A3 (11" x 17")
First copy time*6	3.2 sec.
Continuous copy	Max. 9,999 copies
Resolution	Scan: 600 x 600 dpi, 600 x 400 dpi, 600 x 300 dpi Print: 1,200 x 1,200 dpi, 600 x 600 dpi
Gradation	Equivalent to 256 levels
Zoom range	25% to 400% (25% to 200% using DSPF) in 1% increments
Preset copy ratios	Metric: 10 ratios (5R/5E), Inch: 8 ratios (4R/4E)

Network Colour Scanner

Scan method	Push scan (via control panel) Pull scan (TWAIN-compliant application)
Scan speed*7 (colour & B/W)	One-sided: Max. 120 originals/min. Two-sided: Max. 200 originals/min.
Resolution	Push scan: 100, 150, 200, 300, 400, 600 dpi Pull scan: 75, 100, 150, 200, 300, 400, 600 dpi 50 dpi to 9,600 dpi via user setting*8
File formats	Monochrome: TIFF, PDF, PDF/A-1b, encrypted PDF, XPS Colour/greyscale: TIFF, JPEG, PDF, PDF/A, compact PDF*9, encrypted PDF, XPS
Scan destinations	Scan to e-mail/FTP server/network folder (SMB)/USB drive

• Design and specifications are subject to change without prior notice.
• Active Directory, Windows, Windows Server, and Windows Vista are either registered trademarks or trademarks of Microsoft Corporation in the US and/or other countries. Mac, EtherTalk, AppleTalk, and Bonjour are trademarks of Apple Inc., registered in the US and other countries. PCL is a registered trademark of Hewlett-Packard Company. Adobe and PostScript 3 are either registered trademarks or trademarks of Adobe Systems Incorporated in the US and/or other countries. Command WorkStation, the EFI logo, Fiery, and the Fiery logo are registered trademarks of Electronics for Imaging, Inc. in the US and/or certain other countries. EFI is a trademark of Electronics for Imaging, Inc. in the US and/or certain other countries. Intel and Pentium are trademarks of Intel Corporation or its subsidiaries in the US and/or other countries. All other brand names and product names may be trademarks or registered trademarks of their respective owners.

Document Filing

Document filing capacity*10	Main and custom folders: 35,000 pages or 5,000 files
Stored jobs	Quick file folder: 10,000 pages or 1,000 files
Storage folders	Copy, print, scan
Confidential storage	Quick file folder, main folder, custom folder (max. 1,000 folders) Password protection (for main and custom folders)

Network Printer

Resolution	1,200 x 1,200 dpi, 600 x 600 dpi
Interface	USB 2.0, 10Base-T/100Base-TX/1000Base-T
Supported OS	Windows Server® 2008, Windows Server® 2008 R2, Windows Server® 2012, Windows Server® 2012 R2, Windows Server® 2016, Windows Vista®, Windows® 7, Windows® 8.1, Windows® 10, Mac OS 10.4, 10.5, 10.6, 10.7, 10.8, 10.9, 10.10, 10.11, 10.12, 10.13
Network protocols	TCP/IP (IPv4, IPv6), IPX/SPX (NetWare), EtherTalk (AppleTalk)
Printing protocols**11	LPR, Raw TCP (port 9100), POP3 (e-mail printing), HTTP, FTP for downloading print files, EtherTalk printing, IPP
PDL	Standard: PCL 6 emulation, Adobe® PostScript® 3™ Option*12: XPS
Available fonts	80 fonts for PCL, 139 fonts for Adobe PostScript 3

Fiery® Server (requires optional MX-PE11, MX-KB18, and MX-PX11)

Type	External server
System software	Fiery FS200 Pro
Operating system	Windows 8.1 Professional
CPU	Intel® Pentium® G1820, 2.7 GHz
Memory	4 GB RAM 500 GB HDD
Resolution	1,200 x 1,200 dpi, 600 x 600 dpi (PS, PCL)
Supported OS	Windows Server 2008, Windows Server 2008 R2, Windows Server 2012, Windows Server 2012 R2, Windows Server 2016, Windows Vista, Windows 7, Windows 8.1, Windows 10, Mac OS 10.7, 10.8, 10.9, 10.10, 10.11, 10.12, 10.13
Network protocols	TCP/IP, IPX iPrint, LDAP
Interface	Gigabit Ethernet
Printing protocols**13	LPD, PAP (AppleTalk), SMB, port 9100, IPP 1.1, FTP printing, e-mail printing, Mac Bonjour, WSD
PDL	Adobe PostScript 3
Available fonts	138 fonts for Adobe PostScript 3
Power requirements	100V to 240V, 50/60 Hz
Power consumption	Max. 180 W
Dimensions (W x D x H)	139.7 x 393.7 x 317.5 mm (5 1/2" x 15 1/2" x 12 1/2")
Weight (approx.)	6.8 kg (15 lbs)

*1: Long-edge feeding. *2: Only short-edge feeding can be used with A5 (5 1/2" x 8 1/2") paper.
*3: Paper capacity on minimum required equipment. *4: In a standard measurement environment. May vary depending on operating conditions and environment. *5: HDD capacity depends on procurement and sourcing status. *6: Long-edge feeding of A4 (8 1/2" x 11") sheets from 2nd paper tray, using document glass, MFP in fully ready condition. May vary depending on operating conditions and environment. *7: Based on Sharp's A4 standard chart, using document feeder and long-edge feeding. Using factory default settings with Auto Colour Selection off. Scan speed will vary depending on the type of document and the scan settings. *8: Resolution will vary depending on the size of the scanned area. *9: Requires optional MX-EB11. *10: Storage capacity will vary depending on the type of document and the scan settings. *11: IPv6 is supported only by LPR printing protocol. *12: Requires optional MX-PUX1. *13: IPv6 is supported only by LPD and port 9100 printing protocols.

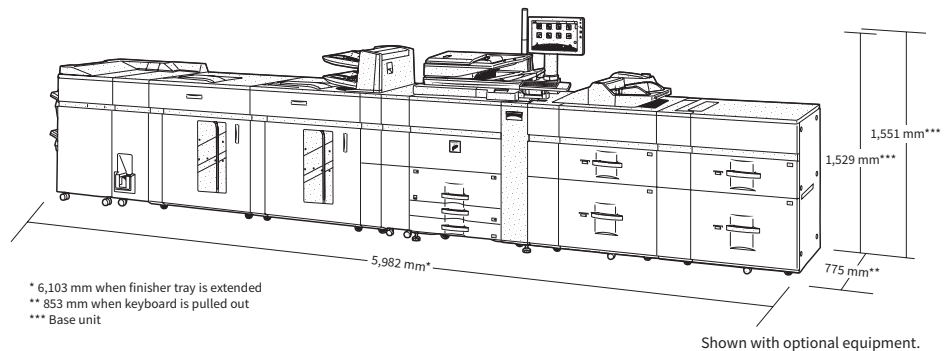

* 6,103 mm when finisher tray is extended
** 853 mm when keyboard is pulled out
*** Base unit

Distributed by:

SHARP

Notice regarding discontinuation of optional units

Thank you for choosing Sharp office products. We'd like to advise that some models and options featured in the Sharp MX-M1205/M1055 product catalog have been discontinued.

Product	Model no.	End of production
High Capacity Stacker	MX-ST10	Discontinued
Paper Cart	MX-CA10	Discontinued

We apologize for any inconvenience and thank you for your understanding.