

SHARP

Be Original.

PN-R903
PN-R703
PN-R603
LCD MONITOR

Stupendous Views from Ultra-Large
LCD Monitors That Bring Images to Life



The simulated image above shows monitors placed inside protective glass casing.

PN-R903—A Gargantuan 90-Inch LCD Monitor

Clearly colossal, Sharp's PN-R903 boasts an ultra-large 90-inch screen that towers seamlessly above other professional LCD monitors in size, quality, and impact. With its full-HD resolution, brilliant image quality, and streamlined profile, this premium professional LCD monitor was designed to lead the large-format digital signage market. Local dimming of the LED backlight partnered with 700 cd/m² brightness keep the PN-R903 well ahead of the pack, ensuring outstanding energy efficiency and high-contrast images that multiply the awe factor.

High-Impact 90-Inch Screen

Sized for eye-catching impact, Sharp's new PN-R903 LCD monitor features a towering **90-inch** screen large enough to realistically showcase life-size images of people. This top-quality LCD colossus excels in a variety of indoor venues, including retail locations, educational institutes, conference rooms, and public spaces. Incorporating a single, seamless screen, the PN-R903 LCD monitor can make an unforgettable impact on any audience.

Breathtaking Image Quality

The 90-inch LCD panel incorporates Sharp's **UV²A*** technology, which ensures highly efficient use of light from the backlight and prevents light leakage. The result: truly bright whites and extremely deep blacks. The panel also boasts a **full-array LED backlight**, in which LED elements are evenly positioned across the entire panel to give on-screen images remarkably uniform brightness.

* UV²A stands for Ultraviolet-induced Multi-domain Vertical Alignment, a photo-alignment technology that ensures uniform alignment of liquid crystal molecules.

High Contrast and Superb Energy Efficiency

For its outstanding black levels, amazing contrast, and superb energy efficiency, the PN-R903 owes much to **local dimming** of its LED backlight. Local dimming allows specific groups of LEDs to be independently dimmed or brightened for greater control of the darkness and brightness in different areas of the monitor, resulting in considerably reduced power consumption. That's why the PN-R903 can deliver significantly better contrast and brightness than conventional LCD monitors while using remarkably less power.

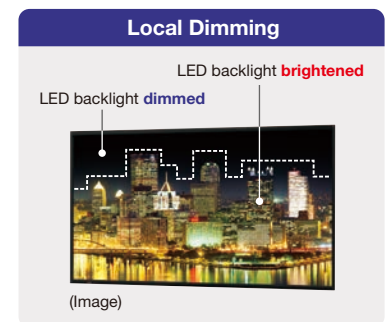

PN-R903/R703/R603 Key Features

Interface Expansion

A standard-equipped interface expansion board gives PN-R903/R703/R603 monitors a comprehensive range of input/output jacks, including the DisplayPort interface.

Choice of Installation Mode

PN-R903/R703/R603 monitors offer a choice of **landscape** or **portrait** installation, allowing customers to select the mode that best suits their display content and application. While portrait installation offers the look and impact of a poster, landscape installation puts wide images on vivid display.

24/7 Operation

Built solid, PN-R903/R703/R603 monitors are ideal for use in 24-hour stores and in other demanding professional applications that require around-the-clock operation seven days a week.

Dual Screen Display

Picture-in-Picture (PIP) mode allows an AV-sourced image to be displayed within a PC-sourced one (or vice versa), while Picture-by-Picture (PbYP) mode puts images from AV and PC sources side by side for split-screen viewing.

Enlarge (Zoom) Display Mode

Multiple monitors can be grouped together to display one enlarged image, thanks to Enlarge (Zoom) Display mode, which corrects the framing of that image to eliminate misalignment between monitors.

Mirror Display Mode (Daisy Chain)*

With Mirror Display mode, the same image can be displayed on a daisy chain of PN-R903/R703/R603 monitors for the powerful impact of visual repetition.

* The number of monitors possible in a daisy chain varies depending on the connection method: Up to 25 (for non-HDCP-encoded content) or 4 (for HDCP-encoded content) via DisplayPort; or up to 5 (for HDCP-encoded content) via DVI.



Built-In Speakers

Built-in speakers eliminate the need for external speakers and keep PN-R903/R703/R603 monitors stylishly streamlined. The speakers emit sound from both sides of the monitors, making them ideal for conveying audio information and playing location-appropriate background music.





PN-R703/R603—Slimline 70/60-Inch LCD Monitors

Ample sized and attractively designed, Sharp's PN-R703/R603 professional LCD monitors have the thin profile, high brightness, and low power consumption to accommodate a wide range of indoor digital signage applications. Exceptionally thin and lightweight, these streamlined monitors measure only 39.4 mm at their thickest point, making for easy, eye-pleasing installation. And with 700 cd/m² brightness and edge-lit LED backlighting, PN-R703/R603 monitors can be counted on for reliable, energy-efficient operation.

Thin, Lightweight Design

PN-R703/R603 monitors owe their exceptionally thin profiles to edge-lit LED backlighting, where LED elements are located at the edges of the panel. Streamlined for a pleasing appearance and minimal protruding parts, these monitors measure only **39.4 mm** at their thickest point and weigh only **43/32 kg**, making for easy placement in offices, public spaces, stores, and other commercial establishments. Stylishly thin profiles also enable attractive wall mounting in a choice of portrait or landscape mode.

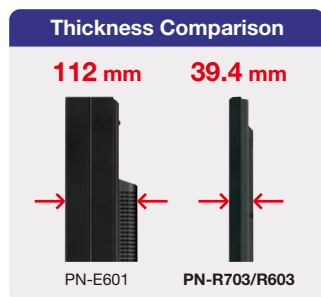

Professional-Standard Image Quality

The PN-R703/R603's 70/60-inch LCD panel incorporates Sharp's **UV²A** technology, which ensures highly efficient use of light from the backlight and prevents light leakage for the display of truly bright whites and extremely deep blacks. A brightness of 700 cd/m² supports these LCD monitors in their digital signage duties.

Energy Efficient

Edge-lit LED backlighting on PN-R703/R603 monitors helps ensure reliable performance with low power consumption. In fact, PN-R703/R603 monitors consume roughly 32.5/50% less energy than conventional CCFL-backlight displays.*

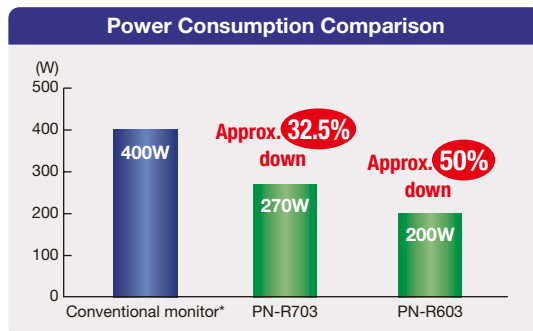

* PN-E601

Specifications

Model Name	PN-R903	PN-R703	PN-R603
Installation	Landscape / Portrait		
LCD Panel	90-inch widescreen (228.7 cm diagonal) UV²A LCD	70-inch widescreen (176.6 cm diagonal) UV²A LCD	60-inch widescreen (152.5 cm diagonal) UV²A LCD
Max. Resolution	1,920 x 1,080 pixels		
Max. Display Colours (approx.)	1.06 billion colours		
Pixel Pitch (H x V)	1.038 x 1.038 mm	0.802 x 0.802 mm	0.692 x 0.692 mm
Brightness*1	700 cd/m²		
Contrast Ratio	1,000,000 : 1 (local dimming set to HIGH) 4,000 : 1 (local dimming OFF)	4,000 : 1	
Viewing Angle (H/V)	176°/176° (CR ≥ 10)		
Active Screen Area (W x H)	1,993.0 x 1,121.0 mm (78 7/16" x 44 1/8")	1,538.9 x 865.6 mm (60 9/16" x 34 1/16")	1,329.1 x 747.6 mm (52 5/16" x 29 7/16")
Response Time	6 ms (grey to grey, avg.)		
Backlight	LED, full array	LED, edge lit	
Computer Input	Analogue RGB (0.7 Vp-p) [75Ω], Digital (conforms to DVI 1.0 standards), DisplayPort 1.1		
Synchronisation	Horizontal/vertical separation (TTL: positive/negative), Sync on green, Composite sync (TTL: positive/negative)		
Plug & Play	VESA DDC2B		
Power Management	VESA DPMS, DVI DMPM		
Video Colour System	NTSC (3.58 MHz, 4.43 MHz), PAL, PAL60, SECAM		
Input Terminals*2	DisplayPort x 1, DVI-I x 1, Mini D-sub 15-pin x 1, HDMI x 2 (HDCP compatible), RS-232C x 1, 3.5 mm-diameter mini stereo jack x 2		
Output Terminals	DisplayPort x 1 (supports video signals only), DVI-D x 1 (HDCP compatible), RS-232C x 1, 3.5 mm-diameter mini stereo jack x 1		
Input/Output Terminals	LAN x 1		
Built-in Speakers	10 W + 10 W		
Mounting	VESA (4 points), 600 x 600 mm (23 5/8" x 23 5/8") pitch; VESA (4 points), 600 x 400 mm (23 5/8" x 15 3/4") pitch	VESA (6 points), 200 x 200 mm (7 7/8" x 7 7/8") pitch; VESA (4 points), 200 x 200 mm (7 7/8" x 7 7/8") pitch	
Power Supply	100V – 240V AC, 50/60 Hz		
Power Consumption	660 W	270 W	200 W
Environmental Conditions	Operating Temperature: 0°C to 40°C Operating Humidity: 20% to 80% RH (no condensation)		
Dimensions (W x D x H) (approx.) (display only)	2,055 x 122 x 1,197 mm (80 7/8" x 4 13/16" x 47 1/8")	1,578 x 39.4 x 916 mm (62 1/8" x 1 9/16" x 36 1/8")	1,378 x 39.4 x 794 mm (54 1/4" x 1 9/16" x 31 1/4")
Weight (approx.)	75 kg (165.3 lbs)	43 kg (94.8 lbs)	32 kg (70.5 lbs)

*1 Brightness depends on input mode and other picture settings. Brightness level will decrease slightly over the lifetime of the product. Due to the physical limitations of the equipment, it is not possible to maintain a precisely constant level of brightness. *2 Use a commercially available connection cable for PC and other video connections.

Dimensions

(PN-R903)

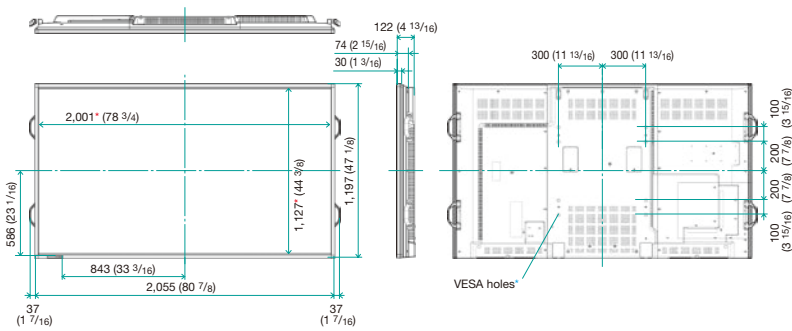

(PN-R703)

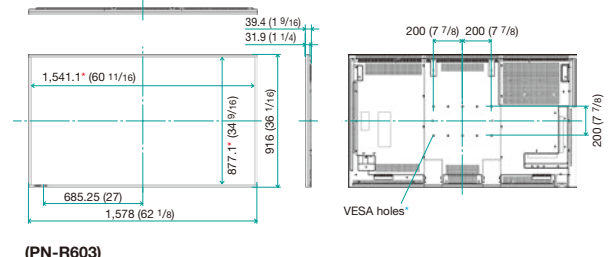

(PN-R603)

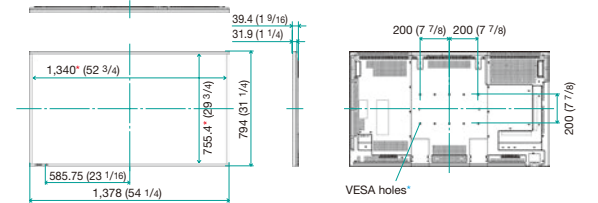

Units: mm (inch)

* Screen dimensions

* To use the VESA-standard mounting bracket, use M6 screws that are 8 to 10 mm plus the thickness of the bracket.

Input/Output Terminals

(bottom)

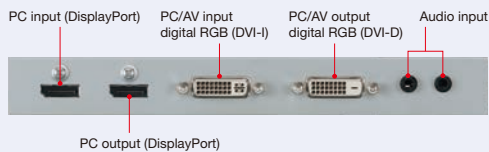

(side)

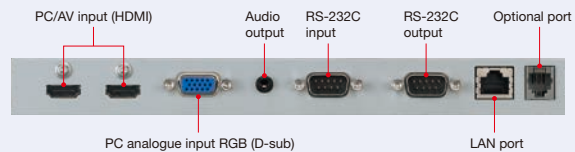

The terms HDMI, HDMI High-Definition Multimedia Interface, and the HDMI Logo are trademarks or registered trademarks of HDMI Licensing Administrator, Inc.

DESIGN AND SPECIFICATIONS ARE SUBJECT TO CHANGE WITHOUT PRIOR NOTICE.



Distributed by:

