

SHARP®

DIGITAL MULTIFUNCTIONAL SYSTEM

MODEL: BP-20M22
BP-21M22
BP-20M24
BP-20M24L
BP-20M28
BP-20M31

Quick Start Manual



BEFORE USING THE MACHINE

Functions of the machine and procedures for placing originals and loading paper



COPIER

Using the copy function



PRINTER

Using the printer function



SCANNER

Using the scan function



SYSTEM SETTINGS

Configuring settings to make the machine easier to use

OPERATION MANUALS AND HOW TO USE THEM

Start Guide



This manual explains basic procedures for using the machine, cautions for safe use of the machine, and information for the administrator. Read this manual before using the machine. For detailed operating procedures and troubleshooting information, see the manuals in PDF format.

User's Manual

Detailed explanations of the functions that can be used on the machine are provided in the "User's Manual". Download the User's Manual from the Web pages in the machine.

For the downloading procedure, see "[DOWNLOADING THE OPERATION GUIDE \(page 5\)](#)".



Other manual

Like the "User's Manual", some manuals as follow can be downloaded from our website and viewed on your computer. Manual types may be updated. For more information, see our website.

User's Manual (Address Book Registration)

This manual explains how to register, edit, and delete the address book.



Software Setup Guide

This guide explains how to install the software and configure settings to use the machine as a printer or scanner.



Troubleshooting

This manual provides answers to frequently asked questions regarding the operation of the machine in each mode.



Quick Start Manual

This manual is intended to help you get started using the basic and convenient functions of the machine.

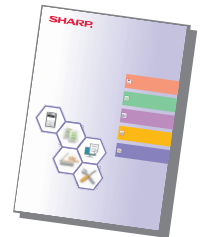

User's Manual (Web Page Settings)

This manual explains the procedures for configuring machine settings from your computer using the web page settings function embedded in the machine.



ACCESSING THE WEB SERVER IN THE MACHINE

When the machine is connected to a network, the machine's built-in Web server can be accessed from a Web browser on your computer.

OPENING THE WEB PAGES

1

Open the System Settings screen.

2

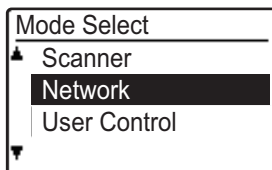

Select "Network" with the [▼] or [▲] key, and press the [OK] key.

3

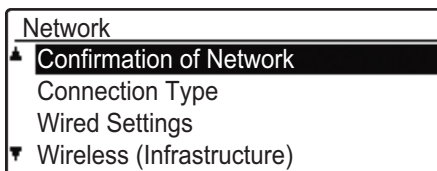

Select "Confirmation of Network" with the [▼] or [▲] key, and press the [OK] key.

4

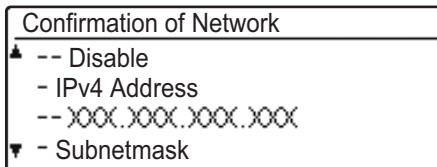

Show and check the IP address with the [▼] or [▲] key.

5



Access the Web server in the machine to open the Web pages.

Start a Web browser on a computer that is connected to the same network as the machine and enter the IP address of the machine.

Recommended Web browsers

Internet Explorer: 11 or higher (Windows®)

Microsoft Edge (Windows®), Firefox (Windows®),

Safari (macOS®), Chrome (Windows®):

Latest version or immediately previous major release

The Web page will appear.

The machine settings may require that user authentication is performed in order to open the Web page. Please ask the administrator of the machine for the password that is required for user authentication.

DOWNLOADING THE OPERATION GUIDE

The Operation Guide, which is a more detailed manual, can be downloaded from the machine's Web pages.

1



Click [Operation Manual Download] in the menu of the Web page.

2

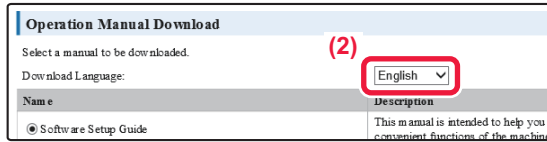

Select the desired language.
Only the displayed languages are supported.

3

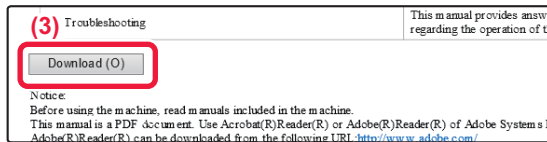

Select the manual you want to download, and click the [Download] button.

TABLE OF CONTENTS

OPERATION MANUALS AND HOW TO USE THEM	2
ACCESSING THE WEB SERVER IN THE MACHINE	4

BEFORE USING THE MACHINE

PART NAMES AND FUNCTION	7
HOW TO USE THE DISPLAY	13
TURNING ON/OFF THE POWER	14
PLACING ORIGINALS	15
LOADING PAPER	17
TRAY SETTINGS	22
USER AUTHENTICATION MODE	23

COPIER

MAKING COPIES	24
COPYING ON SPECIAL PAPER (Bypass Copy)	25

PRINTER

PRINTING IN A WINDOWS ENVIRONMENT	26
PRINTING IN A macOS ENVIRONMENT	28
DIRECTLY PRINTING A FILE IN USB MEMORY	30

SCANNER

ABOUT THE SCANNER FUNCTIONS	31
SCANNING AN ORIGINAL	32

SYSTEM SETTINGS

SYSTEM SETTINGS	33
-----------------------	----



BEFORE USING THE MACHINE

This section provides general information about the machine, including the names and functions of the parts of the machine and its peripheral devices, and the procedures for placing originals and loading paper.

PART NAMES AND FUNCTION

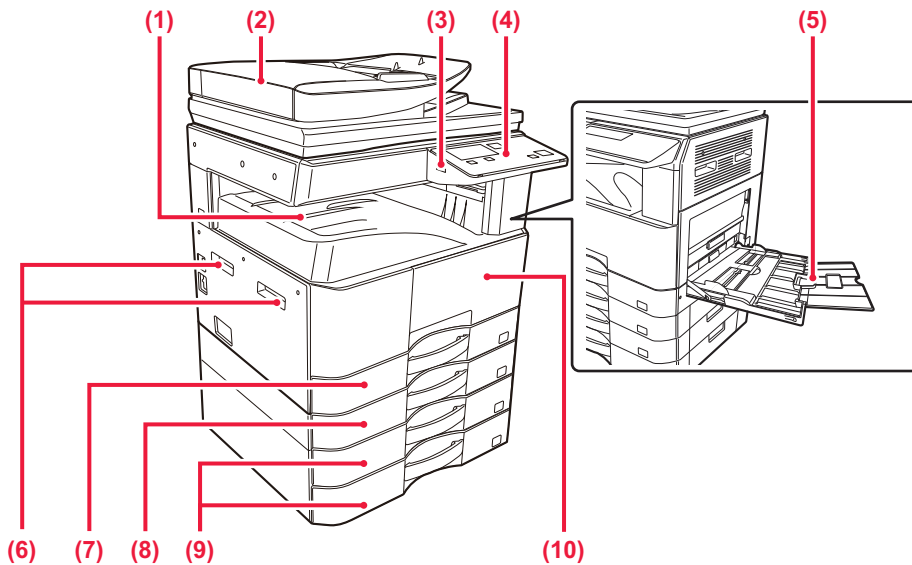

- (1) **Output tray (exit tray cabinet)**
Printed papers are delivered to this tray.
- (2) **Automatic document feeder (BP-20M22/BP-21M22/BP-20M24/BP-20M28/BP-20M31)**
It automatically feeds and scans multiple originals. 2-sided originals can be automatically scanned.
- (3) **USB port (A type)**
This is used to connect a USB device such as a USB memory device to the machine. Supports USB 2.0 (Hi-Speed).
- (4) **Operation panel**
This panel hosts indicators and operation keys.
- (5) **Bypass tray**
Use this tray to feed paper manually. When loading paper, also open the extension tray.
- (6) **Handle**
Grasp it when moving the machine.
- (7) **Tray 1**
Store paper in this tray.
- (8) **Tray 2 (when a 500-sheet paper feed tray is installed)*1**
Store paper in this tray.
- (9) **Tray 3 - 4 (when stand/2x500 sheet paper drawer is installed)*2**
Store paper in this tray. Can only be installed when a 500-sheet paper feed tray is installed.
- (10) **Front cover**
Open this cover to replace a toner cartridge.

*1 BP-20M22/BP-20M24/BP-20M24L: optional, BP-21M22/BP-20M28/BP-20M31: standard

*2 Optional



BEFORE USING THE MACHINE

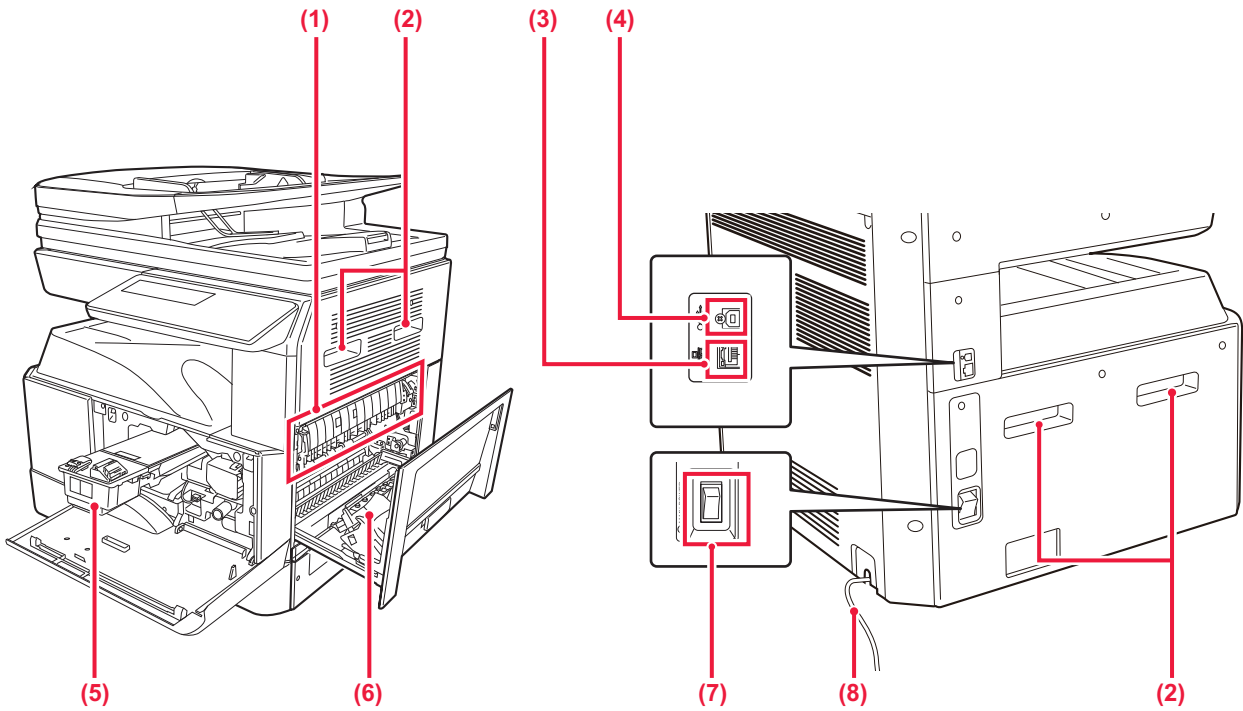

(1) Fusing unit

Heat is applied here to fuse the transferred image onto the paper.



The fusing unit is hot. Take care not to burn yourself when removing a misfeed.

(2) Handle

Grasp it when moving the machine.

(3) LAN connector

Connect the LAN cable to this connector when the machine is used on a network.
Use a shielded LAN cable.

(4) USB port (B type)

The machine does not use this connector.

(5) Toner cartridge

This cartridge contains toner.
When the toner in a cartridge runs out, replace with new one.

(6) Side cover

Open this cover to remove a paper misfeed.

(7) The main power switch

Use this switch to turn on the power for the machine.

(8) Power cord



AUTOMATIC DOCUMENT FEEDER AND DOCUMENT GLASS

BP-20M24L

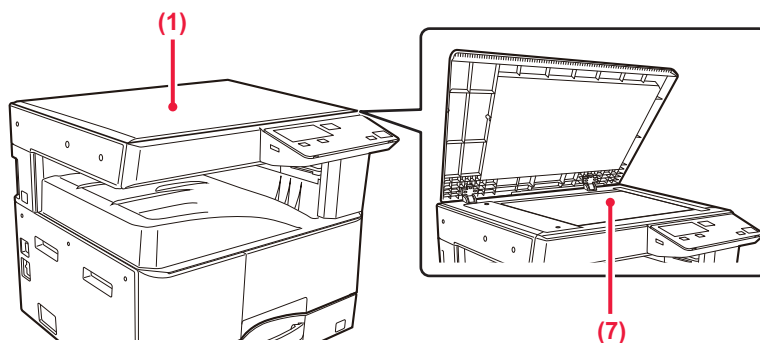

BP-20M22/BP-21M22/BP-20M24/BP-20M28/BP-20M31

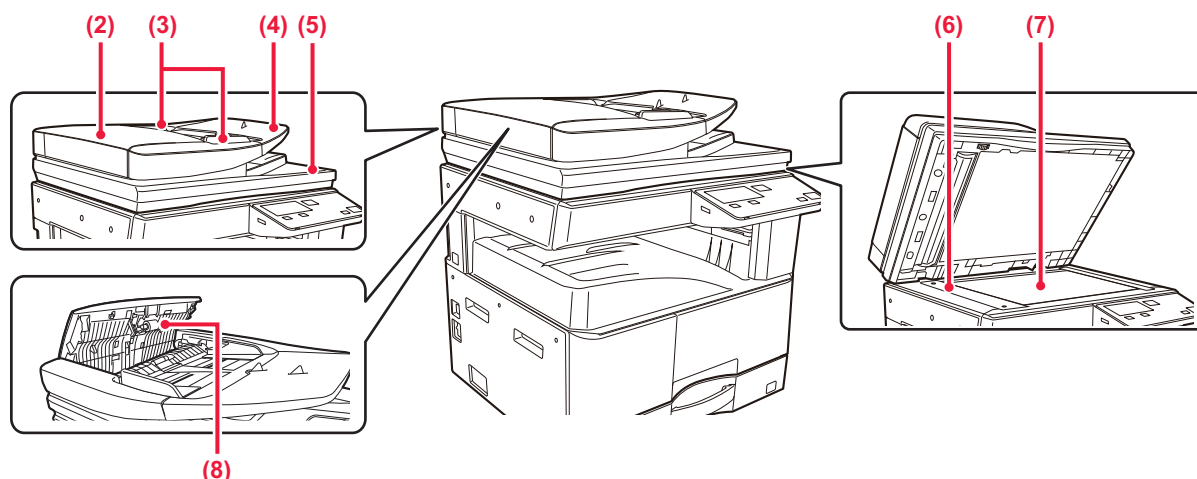

- | | |
|---|--|
| <p>(1) Document cover
Open to make copies from the document glass.</p> <p>(2) Document feeding cover
Open this cover to remove an original misfeed.
This cover is also opened to clean the paper feed roller.</p> <p>(3) Original guides
These guides help ensure that the original is scanned correctly.
Adjust the guides to the width of the original.</p> <p>(4) Document feeder tray
Place the original.
Place the original with the print side facing up.</p> | <p>(5) Original exit tray
The original is discharged to this tray after scanning.</p> <p>(6) Scanning area
Originals placed in the automatic document feeder are scanned here.</p> <p>(7) Document glass
If you want to scan books or other thick originals that cannot be fed through the automatic document feeder, place them on this glass.</p> <p>(8) Paper feed roller
This roller rotates to automatically feed the original.</p> |
|---|--|



OPERATION PANEL

This section describes the names and functions of the respective parts of the operation panel.

Depending on the country and region, display on the operation panel is divided into symbol type and English display type.

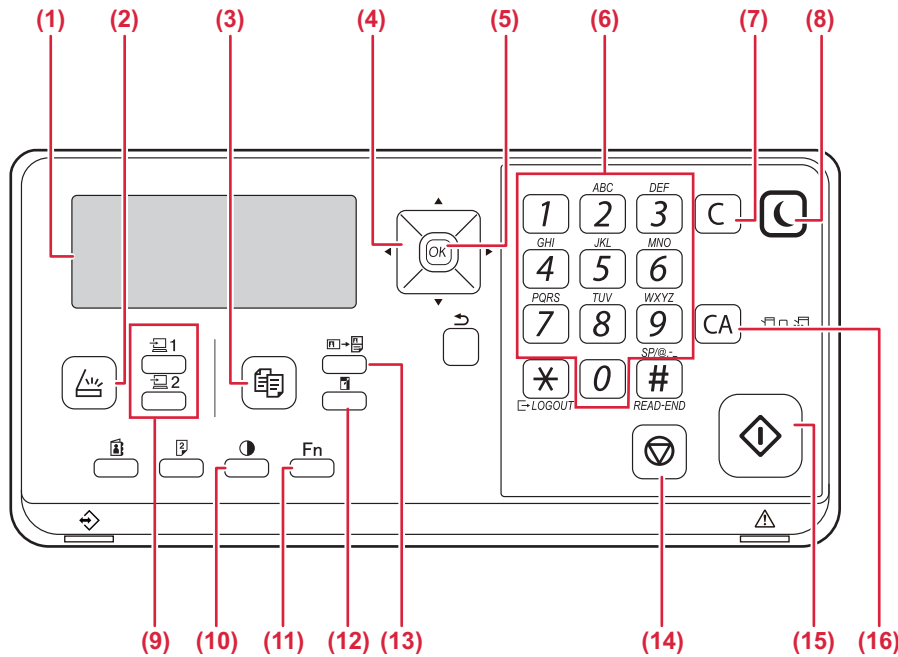

- (1) **Display**
Shows various messages.
- (2) **[SCAN] key / indicator** ()
Press to select scan mode.
- (3) **[COPY] key / indicator** ()
Press to select copy mode.
To check the total number of pages output in copy and print modes hold down the [COPY] key () when the machine is in the standby state. The counts will appear while the key is held down.
The toner level is shown at the bottom of the screen.
- (4) **Arrow keys**
Press to move the highlighting (which indicates that an item is selected) in the display.
- (5) **[OK] key**
Press to enter the selected setting.
- (6) **Numeric keys**
Enter characters/numbers.
- (7) **[C] key**
Press to clear the set number of copies or stop a copy run.
- (8) **[ENERGY SAVE] key / indicator** ()
Press to enter the energy save mode.
- (9) **[PROGRAM 1 / PROGRAM 2] key** ()
Press to use the scanner settings already stored.
- (10) **[EXPOSURE] key** ()
Use to select the exposure mode.
- (11) **[SPECIAL FUNCTION] key** ()
Press to select Special Modes.
- (12) **[ZOOM] key** ()
Press to select a reduction or enlargement copy ratio.
- (13) **[ID CARD COPY] key** ()
Enable ID Card Copy.
- (14) **[STOP] key** ()
Press this key to stop a copy job or scanning of an original.
- (15) **[START] key / indicator**
Press this key to copy or scan an original.
- (16) **[CA] key**
Clears all selected settings and returns the machine to the default settings.

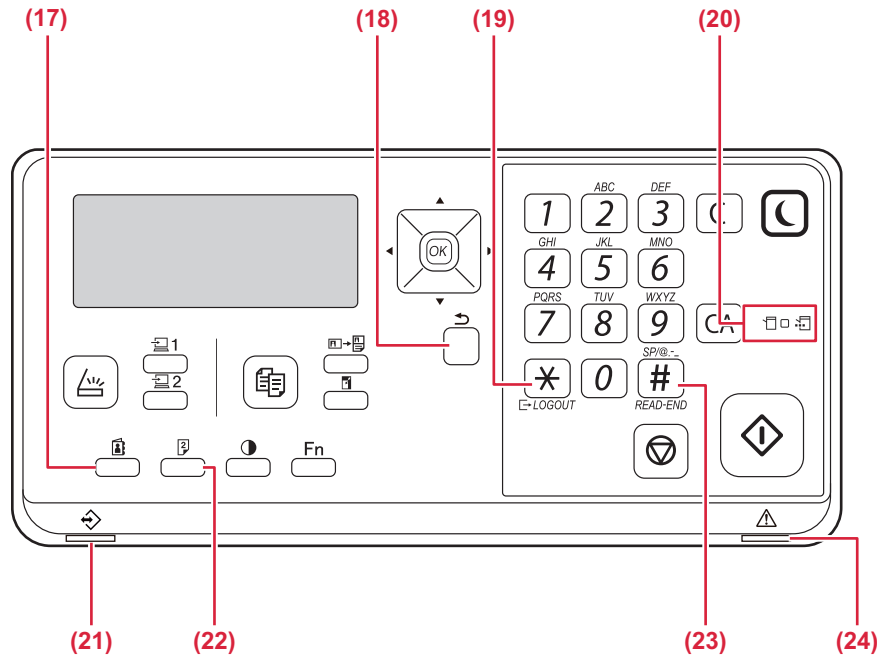
**(17) [ADDRESS] key ()**

Used to select destination address.

(18) [BACK] key ()

Press to return the display to the previous screen.

(19) [LOGOUT] key ()

Press this key to log out after you have logged in and used the machine.

(20) Printer mode indicators

- **DATA indicator** ()

Blinks when print data is being received. Lights steadily during printing.

(21) Data notification indicator

The indicator lights solidly or blinks to indicate the status of a job.

(22) [DUPLEX] key ()

Select the duplex copy/scan mode.

(23) [READ-END] key ()

When copying in sort mode from the document glass, press this key when you have finished scanning the original pages and are ready to start copying.

(24) Error indicator

Lights solidly or blinks to indicate the status of the error.



DISPLAY

This section explains how to use the display.

LEFT MENU AND RIGHT MENU

The display on the machine has a right menu containing frequently used settings and a left menu for display of the settings and setting screens of each function.

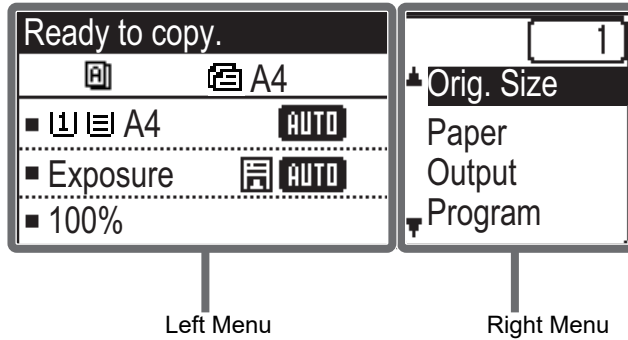

Left Menu (Example: Copy mode)

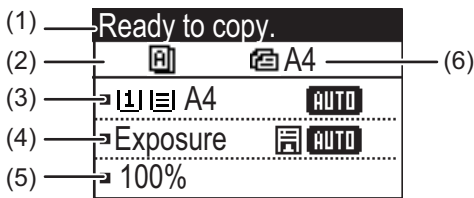

(1) Message display

Messages are displayed regarding machine status and operation.

(2) Special function icon display

Icons of enabled Special Modes will appear.

	1-sided to 2-sided copy		Slow Scan Mode
	2-sided to 2-sided copy		2-Up copy
	2-sided to 1-sided copy		4-Up copy
	Sort		Card shot
	Rotate sort		ID card copy
	Suppress BG		Sharpness

(3) Paper size display

Displays the selected paper size.

(4) Exposure display

Indicates the selected exposure mode.

(5) Copy ratio display

Displays the copy ratio for reduction or enlargement.

(6) Original size display

When the original size is specified in "Orig. Size" in the right menu and the document is loaded in the automatic document feeder, this shows the specified size.

The following icons appear when the original is placed.

None: Document Glass

: Automatic document feeder (one-sided scanning).

: Automatic document feeder (two-sided scanning)



Right Menu

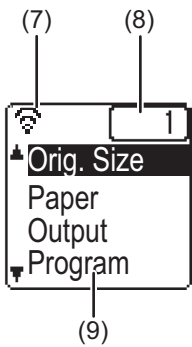

- (7) **Connection status display**
(Models with the wireless LAN function only)
Displayed when wireless LAN is on.

	Wireless infrastructure mode: Connecting
	Wireless infrastructure mode: Not connected
	Wired + wireless access point mode
	Connection failure of wireless LAN device inside machine

- (8) **Number of copies display**
Shows the number of copies set.
- (9) **Function display**
Shows the basic functions of each mode.

HOW TO USE THE DISPLAY

Selecting an item with the arrow keys (up/down)

Use the up/down arrow keys (indicated in this manual by [▼] [▲]) to move to and select (highlight) a setting item in the selection screen. Press the [OK] key to display the screen of the selected setting item. Press [OK] in the setting screen to save your settings.

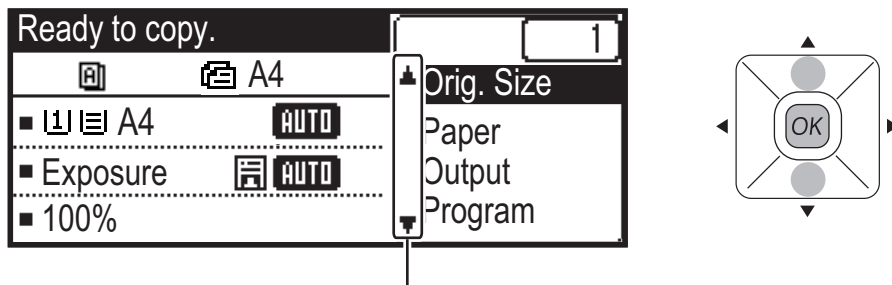

The [▼] [▲] icons appear in the selection screen of settings that use the up/down arrow keys.

Selecting an item with the arrow keys (left/right)

The left/right arrow keys (indicated in this manual by [◀] [▶]) are used to set the exposure and numbers in setting screens. Press the [OK] key to save your settings.

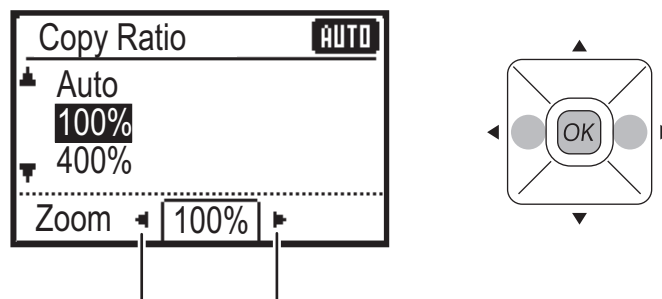

The [◀] [▶] icons appear in setting screens that use the left/right arrow keys.

Use the [BACK] key (↶) to return to the previous setting screen.





TURNING ON/OFF THE POWER

This section describes how to turn on/off the machine's power and how to restart the machine. The power switch is located on the left side of the machine.

Turning on the power

Turn the main power switch to the " | " position.

Turning off the power

Turn the main power switch to the "○" position.

Restart the machine

Turn the main power switch off and then on.

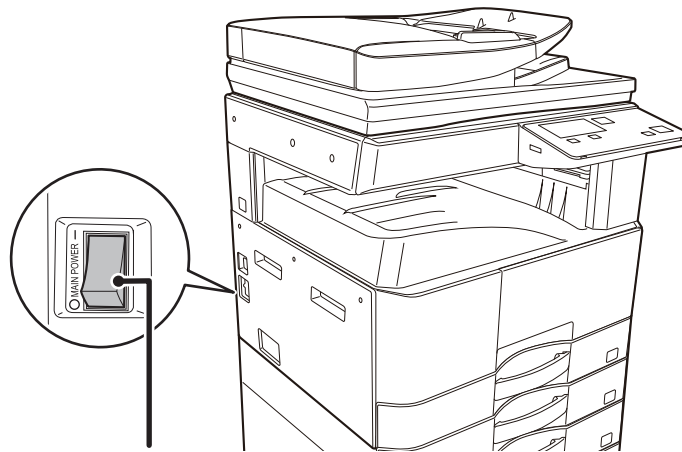

The main power switch



Turn off the main power switch and unplug the power cord if you suspect a machine failure, if there is a bad thunderstorm nearby, or when you are moving the machine.



Print and other functions cannot be used during a brief period of time after the power is turned on or after the machine is wakened from sleep mode. This time is required to allow the machine to prepare for normal printing, and is called the warmup time.



PLACING ORIGINALS

The automatic document feeder can be used to automatically scan many originals at once, and this saves you the trouble of manually feeding each original.

For originals that cannot be scanned using the automatic document feeder, such as a book or a document with notes attached, use the document glass.

USING THE AUTOMATIC DOCUMENT FEEDER

(BP-20M22/BP-21M22/BP-20M24/BP-20M28/BP-20M31)

When using the automatic document feeder, place the originals in the document feeder tray.

Make sure an original has not been placed on the document glass.

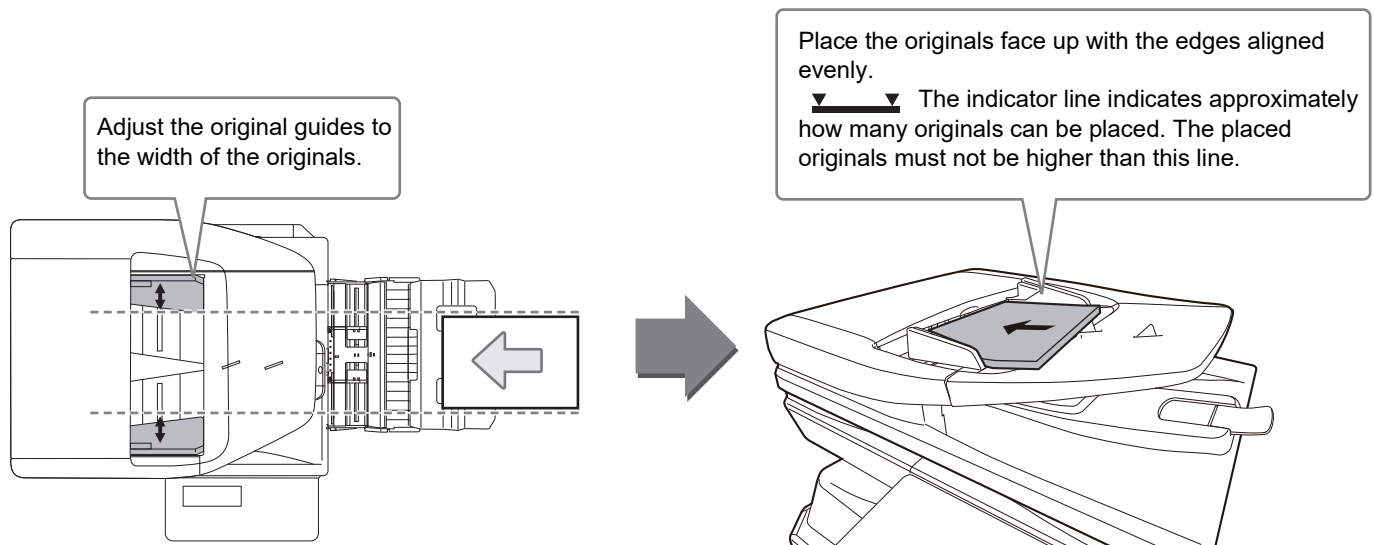

USING THE DOCUMENT GLASS

Take care that your fingers are not pinched when closing the automatic document feeder.

After placing the original, be sure to close the automatic document feeder. If left open, parts outside of the original will be copied black, causing excessive use of toner.

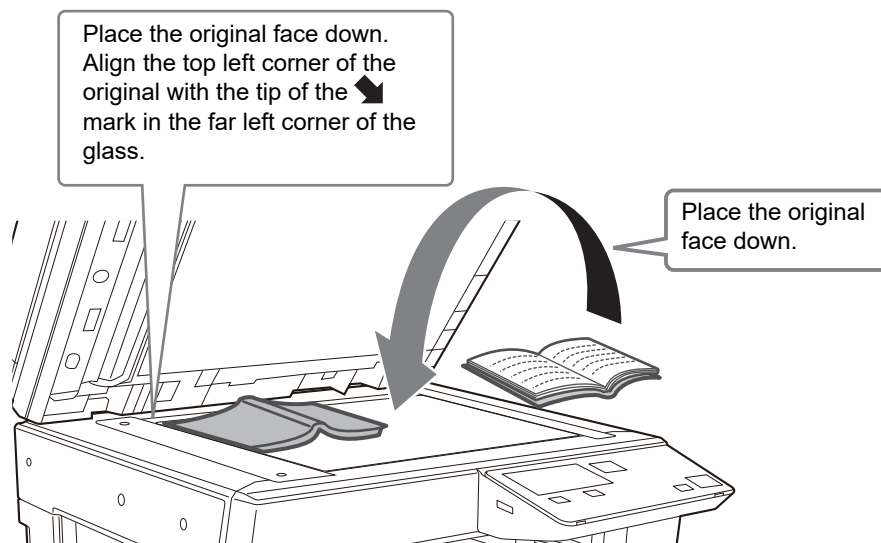



Specifying the size of the original (Document glass)

1

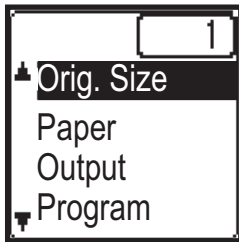

Select "Orig. Size" in the right menu of the base screen of copy mode and press the [OK] key.

2

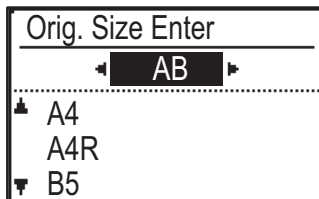

Select Inch or AB with the [◀][▶] keys.

3

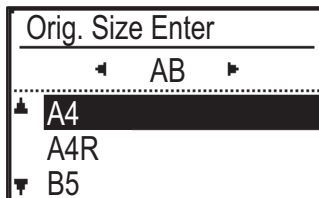

Select the size with the [▼][▲] keys.

4

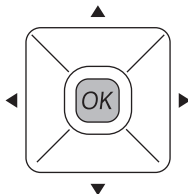

Press the [OK] key.



Set the orientation of the image to ensure that the orientation of the placed original is correctly recognized.
For details, see the User's Manual.



LOADING PAPER

NAMES AND LOCATIONS OF TRAYS

The names of the trays are as follows.

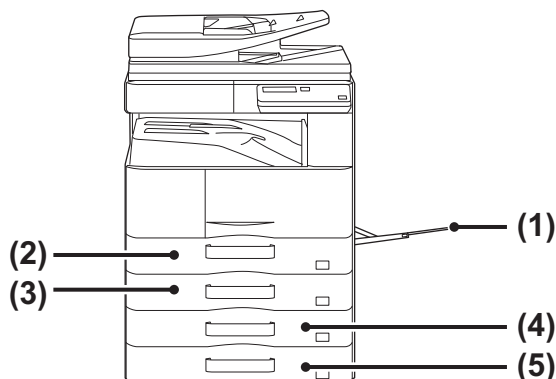

- (1) Bypass tray
- (2) Tray 1
- (3) Tray 2 (when a 500-sheet paper feed tray is installed)
- (4) Tray 3 (when a stand/2x500 sheet paper drawer is installed)
- (5) Tray 4 (when a stand/2x500 sheet paper drawer is installed)

Setting orientation of the print side

The setting orientation varies for the print side of paper, depending on the tray used. For "Letter Head" and "Pre-Printed", set the paper in the reverse orientation.

Place with the print side facing the direction indicated below.

Tray	In normal status	With letter head or pre-printed paper set
Trays 1 - 4	Facing up	Facing down
Bypass tray	Facing down	Facing up

LOAD PAPER INTO THE TRAY 1

1

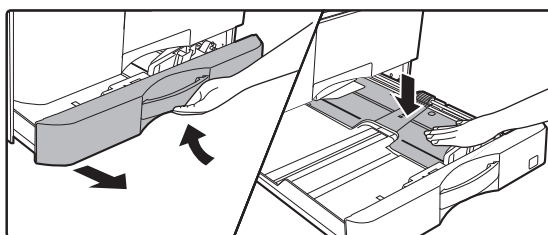

Pull out the paper tray.

Gently pull the tray out until it stops.
Push the centre of the pressure plate down until it locks into place.

2

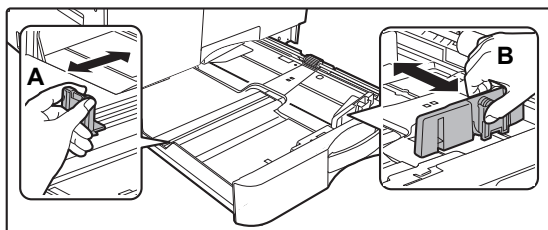

Adjust guide plates A and B to match the longitudinal and transversal dimensions of the paper to be loaded.

The guide plates A and B are slidable. Squeeze the separator plate lever and slide to the desired paper size.



3

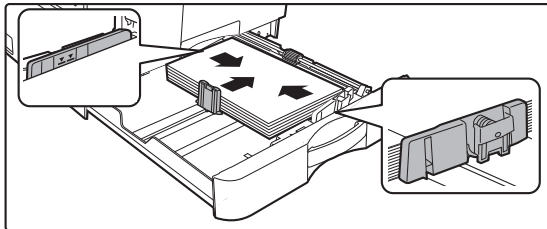
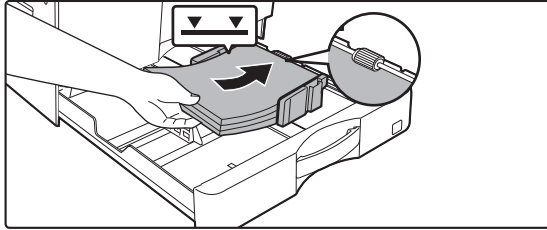

Insert the paper into the tray.

- Load the paper with the print side facing up. Make sure the stack of paper is straight before loading it.
- Place the paper under the roller on the right side of the tray.
- Open the package of the paper and fan the paper well before loading it. If the paper is not fanned, multiple sheets may feed at once and cause a misfeed.

- After loading the paper, close the guides to the paper width not to leave the gap from the guides A and B.
- Do not load the paper as shown below.



- The stack must not be higher than the indicator line.
- Do not add paper.

4

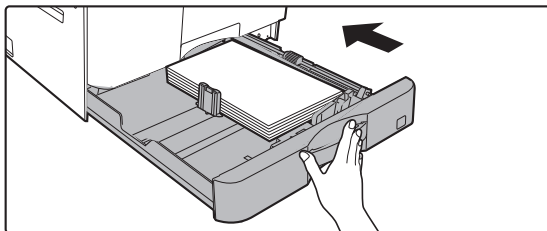

Gently push the paper tray into the machine.

Push the tray firmly all the way into the machine slowly. Forcefully inserting the paper may cause skewed feeding and paper misfeeds.



LOAD PAPER INTO THE TRAY 2 - 4

1

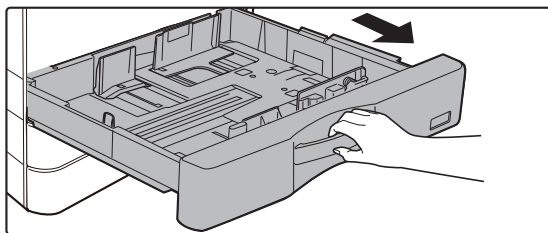

Pull out the paper tray.

Gently pull the tray out until it stops.

To load paper, go to step 3. To load a different size of paper, go to the next step.

2

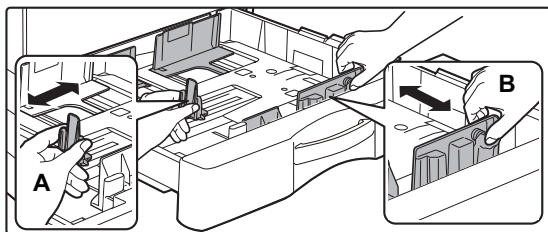

Adjust guide plates A and B to match the longitudinal and transversal dimensions of the paper to be loaded.

The guide plates A and B are slidable. Squeeze the separator plate lever and slide to the desired paper size.

3

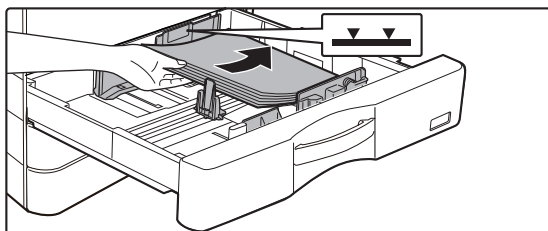

Insert the paper into the tray.

Load the paper with the print side facing up. The stack must not be higher than the indicator line (Maximum of 500 sheets).



- If a paper misfeed occurs, turn the paper over and/or around, and reload.
- If the paper is curled, fix the curl before loading the paper.
- Adjust the divider plate so that there is no gap between the paper and divider plate.
- Do not add paper.
- Do not load the paper as shown below.



4

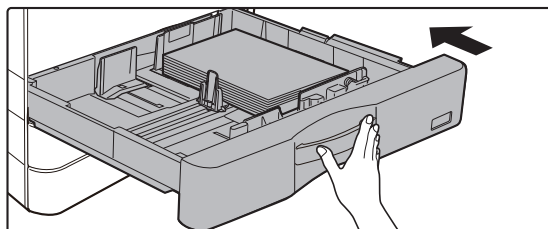

Gently push the paper tray into the machine.

Push the tray firmly all the way into the machine slowly. Forcefully inserting the paper may cause skewed feeding and paper misfeeds.



Bypass tray

1

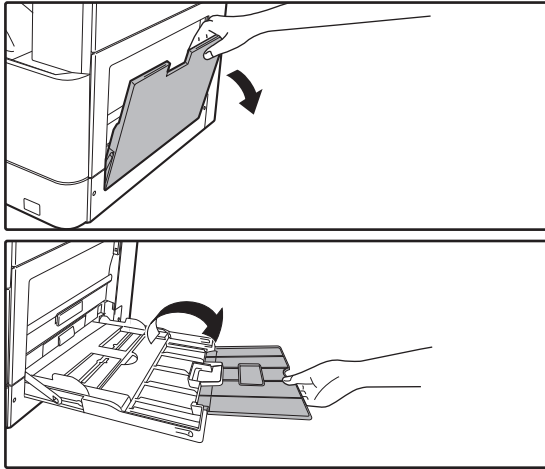

Open the bypass tray.

If you are loading paper of length greater than 250 mm (9-27/32"), open the extension tray.



Do not place heavy objects on the bypass tray or press down on the tray.

2

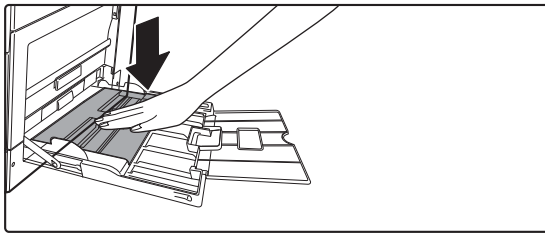

Push the centre of the pressure plate down until it locks into place.

3

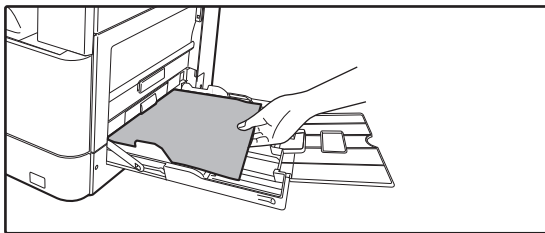

Load the paper with the print side facing down.

Insert the paper along the bypass tray guides all the way into the bypass tray until it stops slowly. Inserting the paper with excessive force may cause the leading edge to fold back. Inserting the paper too loosely may cause skewed feeding or misfeeds.

The paper must not exceed the maximum number of sheets.

4

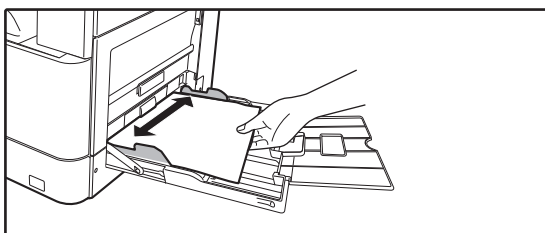

Set the bypass tray guides correctly to the width of the paper.

Adjust the bypass tray guides so that they slightly contact the loaded paper.



- Do not forcefully push in paper that you are loading. This may cause misfeeds.
- If the bypass tray guides are set wider than the paper, move the bypass tray guides in until they correctly fit the width of the paper. If the bypass guides are set too wide, the paper may skew or be creased.
- **How to close the bypass tray.**
Remove any paper remaining in the bypass tray, and press down the centre of the pressure plate until it locks. After you have locked the pressure plate, close the extension tray and then close the bypass tray.

Loading envelopes

Only the front side of envelopes can be printed or copied on. Place the front side facing down.

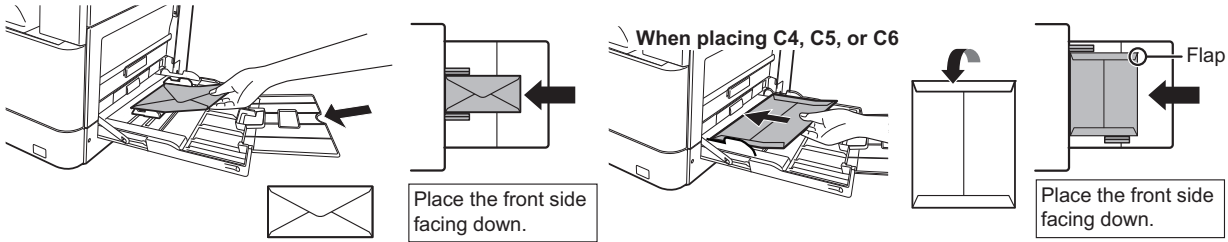

When loading envelopes in the bypass tray, set the paper type.

- ▶ [TRAY SETTINGS \(page 22\)](#)



TRAY SETTINGS

These programs are used to change the paper size and type setting of a tray.

Changing the paper size setting of a tray

If the size of the loaded paper is different from the size shown in the display, follow the steps below to change the paper size setting of the tray.

The paper size setting cannot be changed during copying, printing or when a misfeed has occurred. However, if the machine is out of paper or out of toner, the paper size setting can be changed during copying and printing.

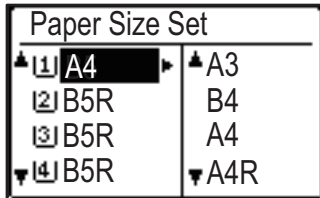

Press the [SPECIAL FUNCTION] key (**Fn**), and press the [▼] or [▲] key to select "Paper Size Set".

Press the [▼] or [▲] key to select the paper tray for which the paper size is being changed. Press the [▶] key and press the [▼][▲] keys to select the paper size.

Press the [OK] key.



[1]: Shows tray "1".

[2]: Shows tray "2".

[3]: Shows tray "3".

[4]: Shows tray "4".

[m]: Shows Bypass tray.

Changing the paper type of a tray

To change the paper type setting for a tray, follow the steps below.

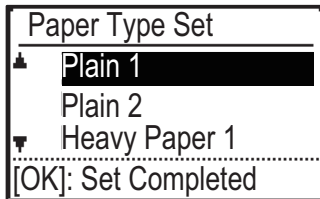

Press the [SPECIAL FUNCTION] key (**Fn**), select "Paper Type Set", select the tray with the [▼] or [▲] key, and press the [OK] key. Select the desired paper type and press the [OK] key.



USER AUTHENTICATION MODE

When user authentication mode is enabled, a count is kept of the pages printed by each account. The page counts can be viewed in the display.

This function is enabled in the system settings. (User Authentication)

Up to 30 can be stored.

USING USER AUTHENTICATION MODE

When user authentication mode is turned on, the account number entry screen is displayed. Enter your account number (five-digit identification number) as explained below before performing a copy or scan operation.



1

Enter your account number (five digits) with the numeric keys.

As the account number is entered, the hyphens (-) change to asterisks (*). If you enter an incorrect digit, press [C] key and re-enter the correct digit.

2

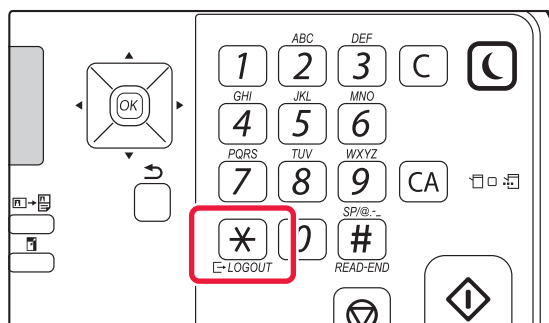

When the copy job is finished, press the [LOGOUT] key (*).



- When a valid account number is entered, the current count of the account will appear in the message display of the base screen. After 6 seconds (factory default setting), the base screen appears.

* In copy mode, the number of sheets remaining until the limit is reached is also shown if Function Limit Setting is enabled in the system settings.

- If an invalid account number is entered in step 1, the account number entry screen reappears.
- When A Warning when Login Fails in the system settings is enabled, a warning message will appear and operation will not be permitted for 1 minute if an invalid account number is entered 3 times in a row.

Copies: 000,000,000
Remaining: 000,000,222



COPIER

This section explains the basic procedures for using the copier function.

MAKING COPIES

This section explains how to set a Copy Ratio.

1



Switch to copy mode.

2

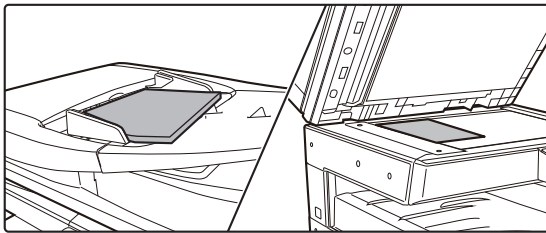

Place the original.

Place the original in the document feeder tray of the automatic document feeder, or on the document glass. If you placed the original on the document glass, select "Orig Size" in the right menu.

► [Specifying the size of the original \(Document glass\) \(page 16\)](#)

3

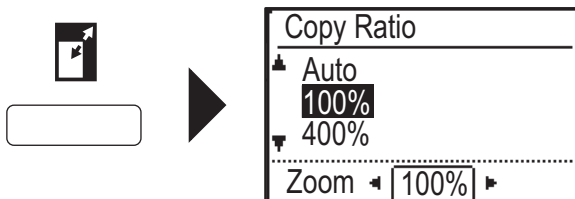

Press the [ZOOM] key ().

Select the ratio with the [▼][▲] keys.

4

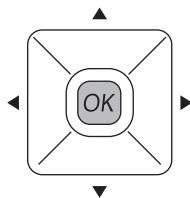

Press the [OK] key.

5

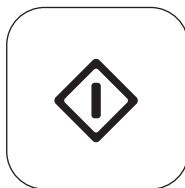

Press the [START] key to start copying.

When making only one set of copies, you do not need to specify the number of copies.



COPYING ON SPECIAL PAPER (Bypass Copy)

This section explains how to load A4 heavy paper 1 in the bypass tray.

1

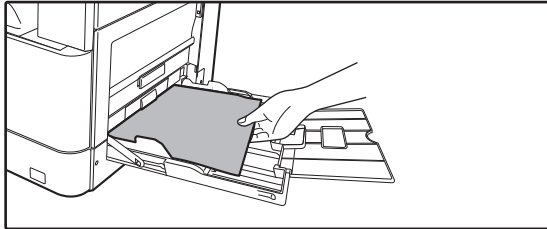

Load the paper with the print side facing down.

When you load paper in the bypass tray, "Paper Type Set" is displayed.

For detailed procedures for selecting the settings from [SPECIAL FUNCTION] key (Fn), see "User's Manual".

2

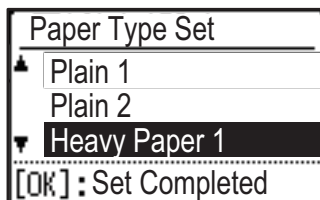

Select the "Heavy Paper 1".

Select the paper type with the [▼][▲] keys. When finished, press the [OK] key.

3

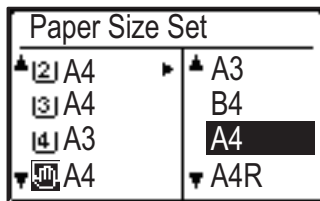

Select the A4 size.

Select the paper size with the [▼][▲] keys. When finished, press the [OK] key.

4



Press the [START] key to start copying.

When making only one set of copies, you do not need to specify the number of copies.



PRINTER

This section explains the basic procedure for printing using the printer driver of the machine. The explanations of screens and procedures are primarily for Windows® 10 in Windows® environments, and macOS 10.12 in macOS environments. The window varies depending on the operating system version, the printer driver version, and the application.

PRINTING IN A WINDOWS ENVIRONMENT

The following example explains how to print an A4 size document from "WordPad", which is a standard accessory program in Windows.

To install the printer driver and configure settings in a Windows environment, see the Software Setup Guide. For information on the available printer drivers and the requirements for their use, see the User's Manual.

1

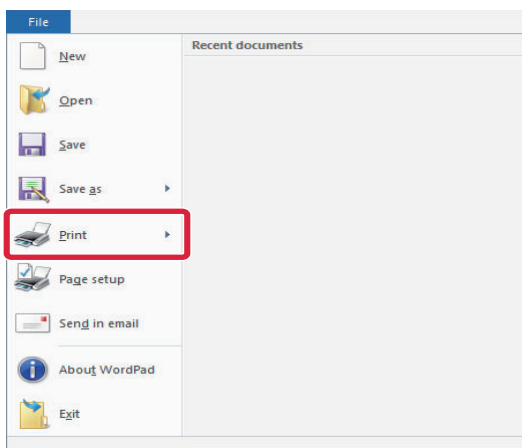

Select [Print] from the [File] menu of WordPad.

2

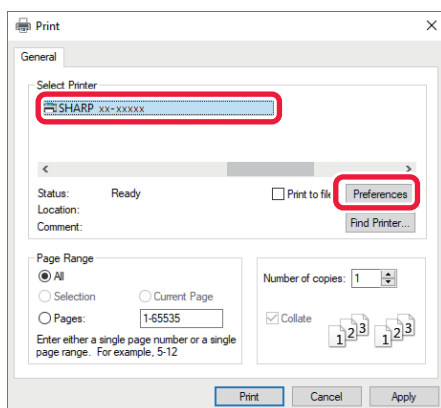

Select the machine's printer driver, and click the [Preferences] button.

If the printer drivers appear as a list, select the name of the printer driver to be used from the list.



3

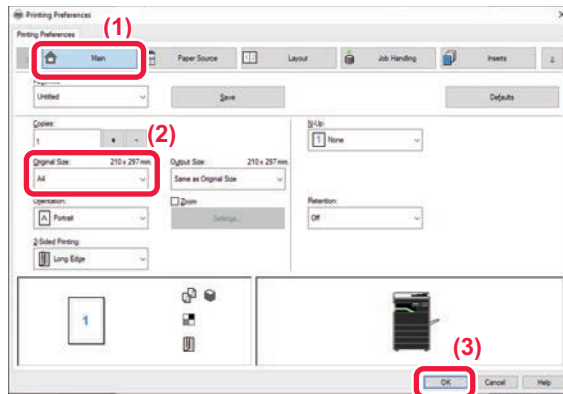

Select print settings.

(1) Click the [Main] tab.

(2) Select the original size.

To select settings on other tabs, click the desired tab and then select the settings.

(3) Click the [OK] button.

- Help can be displayed for a setting by clicking the setting and pressing the [F1] key.
- Click the [Help] button, the Help window will open to let you view explanations of the settings on the tab.

4

Click the [Print] button.

Printing begins.

PRINTING ON ENVELOPES

The bypass tray can be used for envelope printing.

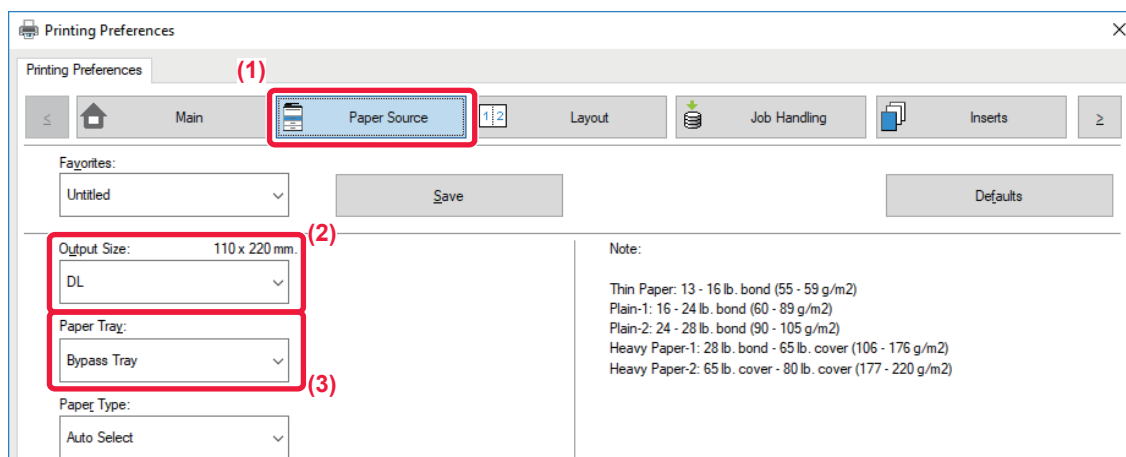

(1) Click the [Paper Source] tab.

(2) Select the envelope size from "Output Size".

When "Output Size" is set to [DL], "Paper Type" is also automatically set to [Envelope].

(3) Select [Bypass Tray] from the "Paper Tray".



Set the paper type of the bypass tray to [Envelope] and load an envelope into the bypass tray.

▶ [Loading envelopes \(page 21\)](#)



PRINTING IN A macOS ENVIRONMENT

The following example explains how to print an A4 size document from "TextEdit", which is a standard accessory program in macOS.

To install the printer driver and configure settings in a macOS environment, see the Software Setup Guide.



On the PS3 expansion kit is required to use the machine as a printer in a macOS environment.

1

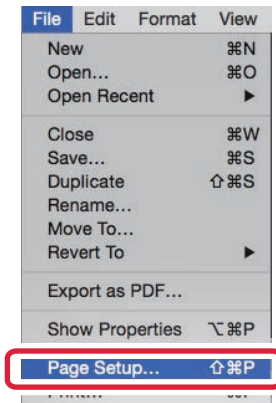

Select [Page Setup] from the [File] menu.

2

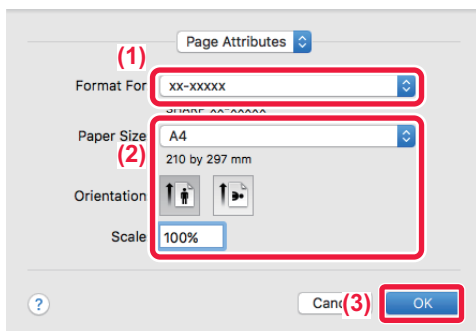

Select paper settings.

- (1) Make sure that the correct printer is selected.
- (2) Select the paper settings.
Set the paper size, paper orientation, and copy ratio.
- (3) Click the [OK] button.

3

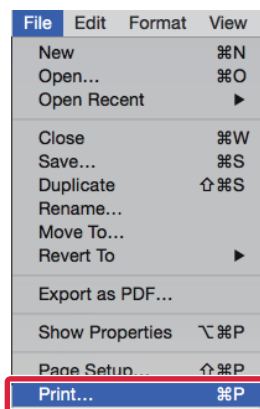

Select [Print] from the [File] menu.



4

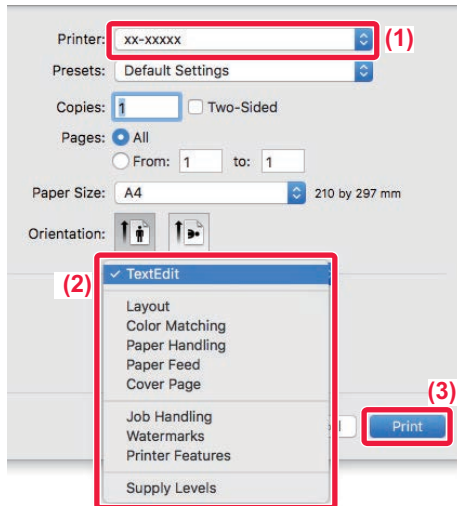

Select print settings.

- (1) Make sure that the correct printer is selected.
- (2) Select items from the menu and configure the settings as needed.
- (3) Click the [Print] button.

PRINTING ON ENVELOPES

The bypass tray can be used for envelope printing.

Select the envelope size in the settings of the application ("Page Setup" in many applications) and then perform the following steps.

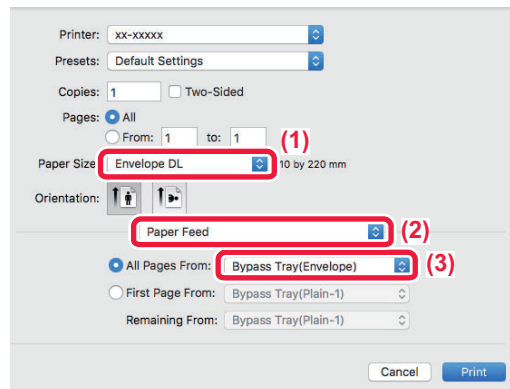

- (1) Select the envelope size from "Paper Size".
- (2) Select [Paper Feed].
- (3) Select [Bypass Tray(Envelope)] from the "All Page From".



Set the paper type of the bypass tray to [Envelope] and load an envelope into the bypass tray.

▶ [Loading envelopes \(page 21\)](#)



DIRECTLY PRINTING A FILE IN USB MEMORY

Files in a USB memory device connected to the machine are printed from the operation panel of the machine without using the printer driver.

The file types (and corresponding extensions) that can be printed directly are shown below.

File Type	TIFF	JPEG	PCL	PS*	PDF*, Compact PDF*, PDF/A*, Compact PDF/A*	PNG
Extension	tiff, tif	jpeg, jpg, jpe, jfif	pcl, prn, txt	ps, prn	pdf	png

* On the PS3 expansion kit is required.

1

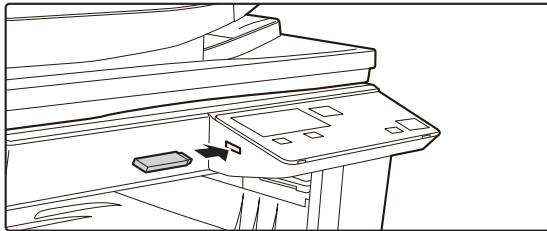

Connect the USB memory device to the machine.

2

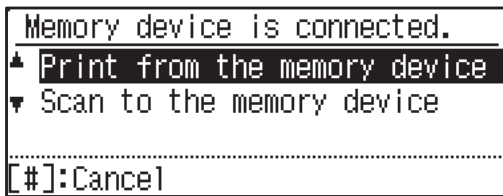

Select "Print from the memory device" with [▲] or [▼] key, and select the file that you wish to print.

A name with "/" to its left is the name of a folder in the USB memory. To display the files and folders in a folder, select the folder and press the [OK] key.

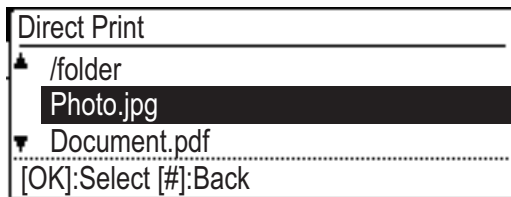

3

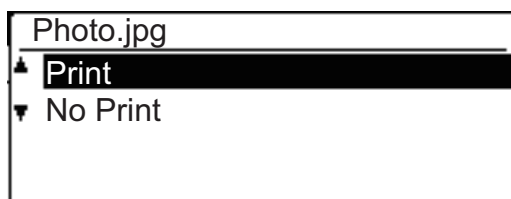

Select "Print" with the [▲] or [▼] key and then press the [OK] key.

When forwarding of the selected file is completed, printing starts.

Print settings can be selected in the machine's Web page. However, if a file that includes print settings (PCL, PS) is selected, the file's print settings will be applied.

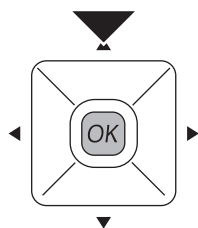

4

Remove the USB memory device from the machine.



SCANNER

This section explains the uses of the network scanner function and the basic procedure for using scan mode.

ABOUT THE SCANNER FUNCTIONS

With this machine a document or photo can be scanned into an image file.

1. Scanning from a TWAIN-compliant application

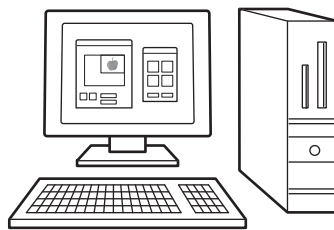

2. Storing the scanned image to a USB flash memory



4. Sending the scanned data to a computer connected to the same network

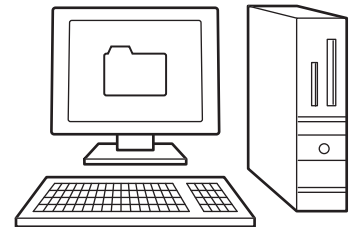

3. Sending the scanned data to FTP server

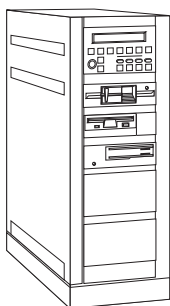

5. Sending the scanned data by E-mail

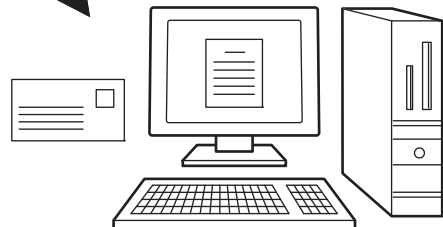



SCANNING AN ORIGINAL

The basic operation for scanning is explained below.

The procedure for sending a scanned file by E-mail to a destination stored in the address book is explained here. For the how to regist Address Book, refer to the "User's Manual (Address Book Registration)".



Switch to scan mode.

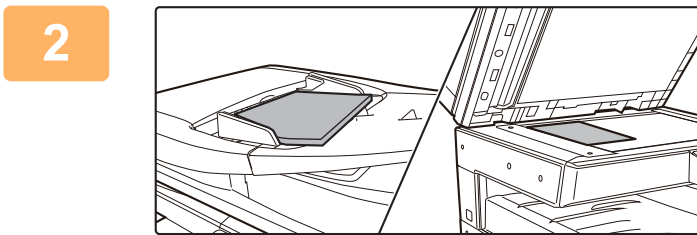

Place the original.

Place the original in the document feeder tray of the automatic document feeder, or on the document glass. If you placed the original on the document glass, select "Orig Size" in the right menu.

▶ [Specifying the size of the original \(Document glass\) \(page 16\)](#)

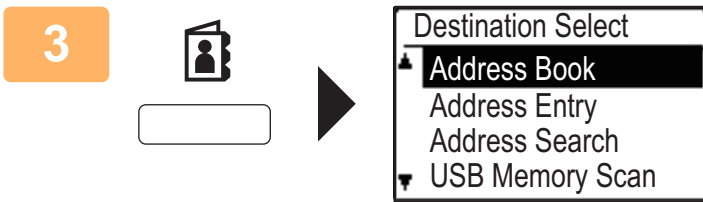

Press the [ADDRESS] Key (👤), select "Address Book" with the [▼] key, and press the [OK] key.

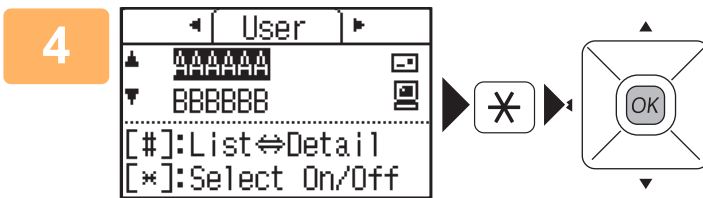

Enter the desired address, press the [LOGOUT] key (✳), and then press [OK] key.



Press the [START] key.

Scanning begins.

If scanning is completed normally, the following screen is appears briefly and then the display returns to the base screen.

To cancel the transmission while "Reading" appears or before the [READ-END] key (#) is pressed, press the [C] or [CA] key.



SYSTEM SETTINGS

The system settings let you adjust the operation of the machine to suit the needs of your workplace. This section briefly introduces several of the system settings.



For detailed explanations of the system settings, see "SYSTEM SETTINGS" in the User's Manual.

SYSTEM SETTINGS

Date & Time Set, Document Feeder Detect Settings and various other settings related to the operation of the machine can be configured in the system settings screen.

The procedure for opening the system settings screen and the items in the screen are explained below.

USING THE SYSTEM SETTINGS

1 **Fn**  

Special Function	
▲	Display Contrast
	Total Count
	List Print
▼	System Settings

Press the [SPECIAL FUNCTION] key (Fn), and select "System Settings" with the [▼] or [▲] key and press the [OK] key.

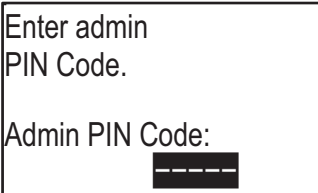
2 

Enter the administrator PIN code with the numeric keys.

- "*" appears for each digit that you enter.
- The mode selection screen appears.

3 

Select the desired mode with the [▼] or [▲] key, and press the [OK] key.

4 **Select the desired setting with the [▼] or [▲] key.**





5

Press the [OK] key and follow the instructions in the setting screen.

Several settings will have checkboxes in front of them. To enable a function (make a checkmark appear), press the [OK] key. To disable the setting, press the [OK] once again to remove the checkmark. To configure a setting that has a checkbox, go to step 6.

6

To use another setting for the same mode, select the desired setting with the [▼] or [▲] key.

To use a setting for a different mode, press the [BACK] key (↩) and select the desired mode. To exit the system settings, press the [CA] key.

WHAT YOU CAN DO IN THE SYSTEM SETTINGS

The following settings can be configured in system settings.

Some settings may not appear on the display of the machine, or in the Web browser on your computer. Some settings may not appear due to the specifications of your machine and the peripheral devices that are installed.

Menu	Overview	
System Settings	Configure the main settings for the machine such as date settings and paper tray settings. You can configure the following settings.	
	Change Admin PIN	Use this function to change administrator PIN code.
	Initial Setting	The default settings for operation of the machine can be configured.
	Copier	You can select copy settings.
	Printer	You can select print settings.
	Scanner	You can select scanner settings.
	Network	You can select network settings.
	User Control	User Control is used to configure settings for user authentication.
	Device Control	These settings are used to configure settings for hardware functions of the machine.
	Operation Setting	These settings are used to configure various settings related to the operation panel.
	Energy Save	These settings are used to configure energy saving settings.
	List Print	This is used to print lists and reports that are only for use by the administrator of the machine.
	Security Settings	The following settings are related to security.

Please note

- For information on your operating system, please refer to your operating system manual or the online Help function.
- The explanations of screens and procedures in a Windows environment are primarily for Windows 10®. The screens may vary depending on the version of the operating system or the software application.
- The explanations of screens and procedures in a macOS environment are based on macOS 10.12 in the case of macOS. The screens may vary depending on the version of the operating system or the software application.
- Wherever model name "xx-xxxx" appears in this manual, please substitute your model name.
- Considerable care has been taken in preparing this manual. If you have any comments or concerns about the manual, please contact your dealer or nearest SHARP Service Department.
- This product has undergone strict quality control and inspection procedures. In the unlikely event that a defect or other problem is discovered, please contact your dealer or nearest SHARP Service Department.
- Aside from instances provided for by law, SHARP is not responsible for failures occurring during the use of the product or its options, or failures due to incorrect operation of the product and its options, or other failures, or for any damage that occurs due to use of the product.

Warning

- Reproduction, adaptation or translation of the contents of the manual without prior written permission is prohibited, except as allowed under copyright laws.
- All information in this manual is subject to change without notice.

Illustrations and the operation panel and display shown in this manual

The peripheral devices are generally optional, however, some models include certain peripheral devices as standard equipment. The explanations in this manual assume that 500-sheet paper feed tray and Stand/2x500 sheet paper drawer are installed on the BP-20M24.

For some functions and procedures, the explanations assume that devices other than the above are installed.

<p>The display screens, messages, and key names shown in the manual may differ from those on the actual machine due to product improvements and modifications.</p>
--

SHARP[®]
SHARP CORPORATION