

## Quick Start Guide



### BEFORE USING THE MACHINE

Functions of the machine and procedures for placing originals and loading paper



### COPIER

Using the copy function



### PRINTER

Using the printer function



### FACSIMILE

Using the fax function



### SCANNER

Using the scan function



### DOCUMENT FILING

Storing jobs as files on the local drive



### SETTING MODE

Configuring settings to make the machine easier to use

# HOW TO USE MANUALS

## Start Guide

This manual explains basic procedures for using the machine, cautions for safe use of the machine, and information for the administrator. Read this manual before using the machine.

For detailed operating procedures and troubleshooting information, see the user's manual.

## User's Manual

Detailed explanations of the functions that can be used on the machine are provided in the "User's Manual".

The manuals for this machine are uploaded to a website. Tap [User's Manual] on the touch panel of the machine and a QR code will be displayed. Scan the QR code with a smartphone or other device to go to the website where manuals are available.

You can download various manuals from the website. The user's manual is also uploaded in HTML format and can be viewed on your smartphone or computer.

## Software Setup Guide

This guide explains how to install the software and configure settings to use the machine as a printer or scanner.

## Cloud Connect Guide

This guide explains how to connect the machine to a cloud service on the Internet, enabling you to upload scanned data and print data stored in the cloud.

## AirPrint Guide

This guide explains how to use AirPrint.

## Downloading the User's Manual in PDF format

Access the website from the following URL or QR code.

The website is displayed in English.

Switch to your preferred language before viewing and downloading the manual.

In addition, the same "User's Manual", you can see download to your computer from the Web site.

\* Manual types may be updated. For more information, see our website.

URL:

<https://global.sharp/restricted/products/copier/downloads/manuals/select.html>



# TABLE OF CONTENTS

HOW TO USE MANUALS .....	2
--------------------------	---

## BEFORE USING THE MACHINE

PART NAMES AND FUNCTIONS .....	5
TURNING ON/OFF THE POWER .....	7
OPERATION PANEL .....	8
MOTION SENSOR .....	9
PLACING ORIGINALS .....	11
ADJUSTING THE VOLUME .....	12
LOADING PAPER .....	13
SAVING CONTACTS IN THE ADDRESS BOOK .....	21
ACCESSING THE WEB SERVER IN THE MACHINE .....	22
USER AUTHENTICATION .....	23
FUNCTIONS THAT CAN BE USED ON THE MACHINE .....	24

## COPIER

MAKING COPIES .....	25
COPYING ON SPECIAL PAPER (Bypass Copy) .....	27

## PRINTER

PRINTING IN A WINDOWS ENVIRONMENT .....	29
PRINTING IN A macOS ENVIRONMENT .....	31
DIRECTLY PRINTING A FILE IN USB MEMORY .....	33

## FACSIMILE

SENDING A FAX .....	34
---------------------	----

## SCANNER

NETWORK SCANNER FUNCTION.....	36
SCANNING AN ORIGINAL .....	37

## DOCUMENT FILING

SAVING A DOCUMENT ONLY (Scan to Local Drive).....	39
PRINTING A SAVED FILE.....	42

## SETTING MODE

SETTING MODE .....	43
--------------------	----



# BEFORE USING THE MACHINE

This section provides general information about the machine, including the names and functions of the parts of the machine and its peripheral devices, and the procedures for placing originals and loading paper.

## PART NAMES AND FUNCTIONS

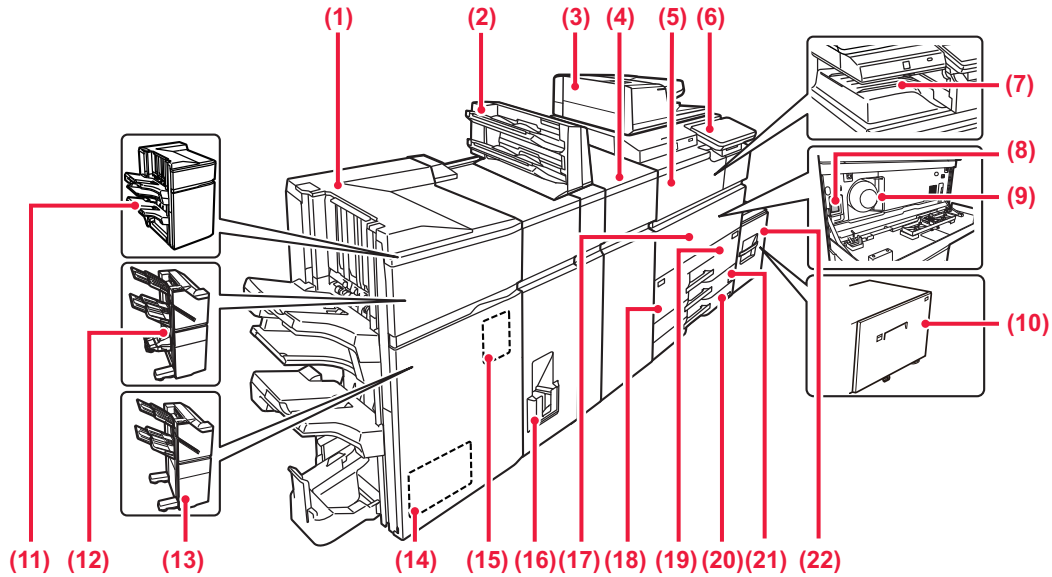

- |  |  |
|--|--|
| <p>(1) <b>Saddle Stitch Finisher (large stacker)*</b><br/>This staples and folds paper. A punch module can also be installed to punch holes in output paper.</p> <p>(2) <b>Inserter*</b><br/>Covers and insertion sheets to be inserted into printed sheets can be loaded.<br/>Using the manual finishing function, you can directly feed paper into the finisher (large stacker) or saddle stitch finisher (large stacker) to staple, punch or fold the paper.</p> <p>(3) <b>Automatic document feeder</b><br/>It automatically feeds and scans multiple originals. 2-sided originals can be automatically scanned.</p> <p>(4) <b>Curl correction unit*</b><br/>This unit corrects curls in printed paper.</p> <p>(5) <b>Paper pass unit*</b><br/>Relay between the machine and the finisher, finisher (large stacker), saddle stitch finisher or saddle stitch finisher (large stacker).</p> <p>(6) <b>Operation panel</b><br/>This panel hosts the [Power] button, Information indicator and touch panel.<br/>Use the touch panel to operate each of these functions.<br/>▶ <a href="#">OPERATION PANEL (page 8)</a></p> <p>(7) <b>Output tray*</b><br/>Output is delivered to this tray.</p> <p>(8) <b>Main power switch</b><br/>Use this button to turn the machine's power on and off.<br/>▶ <a href="#">TURNING ON/OFF THE POWER (page 7)</a></p> <p>(9) <b>Toner cartridge</b><br/>This cartridge contains toner.<br/>When the toner in a cartridge runs out, replace with new one.</p> <p>(10) <b>Tray 5 (MX-LC19)*</b><br/>Store paper in this tray. A maximum of 3000 sheets (80 g/m<sup>2</sup> (20 lbs.)) of paper can be loaded.</p> <p>(11) <b>Finisher (large stacker)*</b><br/>This staples paper. A punch module can also be installed to punch holes in output paper.</p> | <p>(12) <b>Saddle Stitch Finisher*</b><br/>This staples and folds paper. A punch module can also be installed to punch holes in output paper.<br/>You can also perform stapling manually.</p> <p>(13) <b>Finisher*</b><br/>This staples paper. A punch module can also be installed to punch holes in output paper.<br/>You can also perform stapling manually.</p> <p>(14) <b>Trimming module*</b><br/>This trims the excess of saddle-stitched output.</p> <p>(15) <b>Punch module*</b><br/>This is used to punch holes in output. Requires a finisher, finisher (large stacker), saddle stitch finisher or saddle stitch finisher (large stacker).</p> <p>(16) <b>Folding unit*</b><br/>This folds and outputs paper.</p> <p>(17) <b>Front cover</b><br/>Open this cover to switch the main power switch to "On" or "Off" to replace a toner cartridge.</p> <p>(18) <b>Tray 1</b><br/>Store paper in this tray. A maximum of 1250 sheets (20 lbs. (80 g/m<sup>2</sup>)) of paper can be loaded.</p> <p>(19) <b>Tray 2</b><br/>Store paper in this tray. A maximum of 850 sheets (20 lbs. (80 g/m<sup>2</sup>)) of paper can be loaded.</p> <p>(20) <b>Tray 3</b><br/>Store paper in this tray. A maximum of 500 sheets (20 lbs. (80 g/m<sup>2</sup>)) of paper can be loaded.</p> <p>(21) <b>Tray 4</b><br/>Store paper in this tray. A maximum of 500 sheets (20 lbs. (80 g/m<sup>2</sup>)) of paper can be loaded.</p> <p>(22) <b>Tray 5 (BP-LC11)*</b><br/>Store paper in this tray. A maximum of 3500 sheets (20 lbs. (80 g/m<sup>2</sup>)) of paper can be loaded.</p> |
|--|--|

\* Peripheral device. For more information, see the User's Manual.



# BEFORE USING THE MACHINE

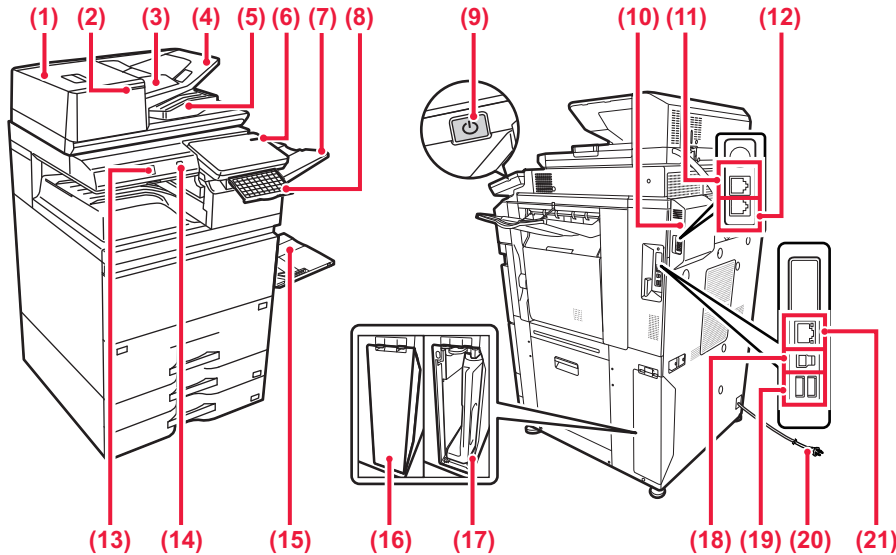

- (1) **Document feeding area cover**  
Open this cover to remove an original misfeed or clean the paper feed roller.
- (2) **Original setting indicator**  
This indicator lights when the document is correctly loaded on the document feeder tray.
- (3) **Original guides**  
These guides help ensure that the original is scanned correctly. Adjust the guides to the width of the original.
- (4) **Document feeder tray**  
Originals must be placed face up.
- (5) **Original exit tray**  
The original is discharged to this tray after scanning.
- (6) **Main power indicator**  
This lamp lights up when the machine's main power switch is in the "I" position.
- (7) **Exit tray unit (right tray)\***  
Set so that paper is output into this tray as required.
- (8) **Keyboard**  
Use this as a substitute for the soft keyboard displayed on the touch panel.  
When not being used, it can be stored under the operation panel.
- (9) **[Power] button**  
Use this button to turn the machine's power on and off.  
▶ [TURNING ON/OFF THE POWER \(page 7\)](#)
- (10) **Facsimile expansion kit\***
- (11) **Extension phone jack (TEL)\***  
When the fax function of the machine is used, an extension phone can be connected to this jack.
- (12) **Telephone line jack (LINE)\***  
When the fax function of the machine is used, the telephone line is connected to this jack.
- (13) **Motion sensor**  
This sensor detects the presence of a person that approaches the machine, and automatically wakes the machine from sleep mode (Motion Sensor Mode Only).
- (14) **USB port (A type)**  
This is used to connect a USB device such as a USB memory device to the machine.  
Supports USB 2.0 (Hi-Speed).
- (15) **Bypass tray**  
Use this tray to feed paper manually.  
When loading paper larger than 8-1/2" x 11"R or A4R, pull out the extension guide.  
▶ [Bypass tray \(page 16\)](#)
- (16) **Cover for toner collection container**  
Open this cover when you need to replace the toner collection container.
- (17) **Toner collection container**  
This container collects excess toner that remains after printing.
- (18) **USB connector (B type)**  
The machine does not use this connector.
- (19) **USB port (A type)**  
This is used to connect a USB device such as a USB memory device to the machine.  
Supports USB3.0 (SuperSpeed).
- (20) **Power plug**
- (21) **LAN connector**  
Connect the LAN cable to this connector when the machine is used on a network.

\* Peripheral device. For more information, see the User's Manual.



# TURNING ON/OFF THE POWER

This section describes how to turn on/off the machine's power and how to restart the machine.

Operate two power switches: the main power switch inside the front cover, located in the lower left corner, and the [Power] button on the operation panel.

## Turning on the power

- Turn the main power switch to the " | " position.
- When the main power indicator lights in blue, press the [Power] button.

## Turning off the power

- Press the [Power] button to turn off the power, and then tap the [Power Off] key.  
To turn off the power for an extended time, press the [Power] button to turn off the power, and switch the main power switch to the " ⏻ " position after the operation panel screen disappears.

## Restart the machine

- Press the [Power] button to turn off the power, and tap the [Power off] key on the touch panel. After that, press the [Power] button again to turn on the power.

Main power indicator [Power] button

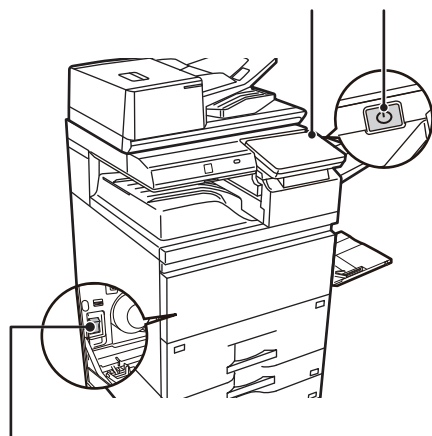

Main power switch



- When turning off the main power switch, press the [Power] button on the operation panel and then turn the main power switch to the " ⏻ " position.  
In a sudden case of main power outage, turn the power for the machine back on and then turn it off in the correct order. If the machine is left for a long time with the main power having been turned off prior to the [Power] button being turned off, abnormal noises, degraded image quality or other problems may result.
- Turn off both the [Power] button and the main power switch and unplug the power cord if you suspect a machine failure, if there is a bad thunderstorm nearby, or when you are moving the machine.



- When using the fax or Internet fax function, always keep the main power switch in the " | " position.
- In order for some settings to take effect, the machine must be restarted. In some states of the machine, restarting with the [Power] button may not make the settings take effect. In this case, turn off the main power switch and then turn it on again.



## OPERATION PANEL

Pressing the [Home Screen] key on the operation panel displays the home screen on the touch panel. The home screen displays the keys for selecting modes or functions.

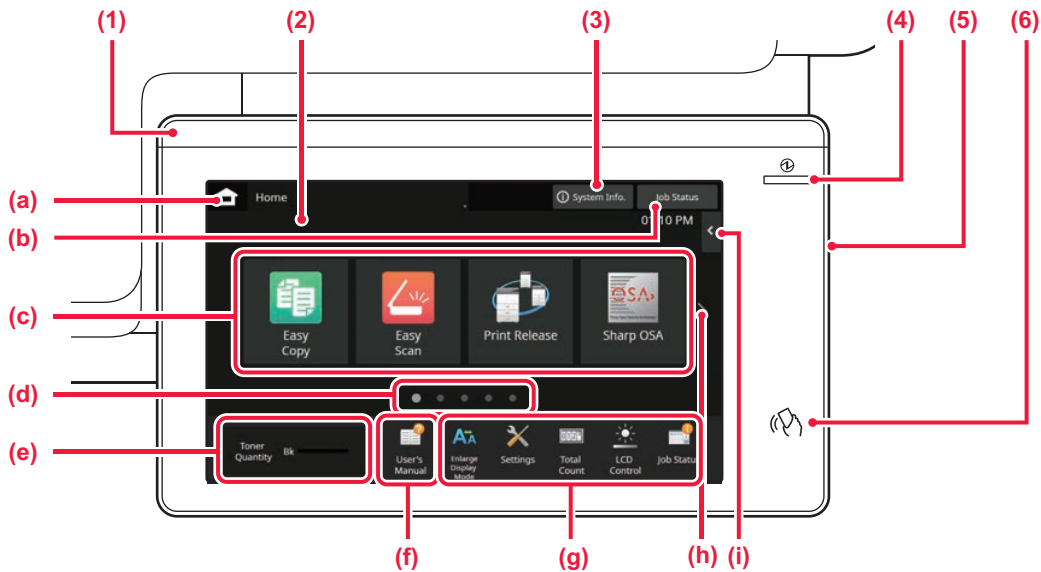

- (1) **Information indicator**  
The indicator illuminates light or blink to notify you when the power to the machine is turned on or off, when a user logs in to the machine, when a fax is being received, or when an error occurs in the machine.
- (2) **Touch Panel**  
Messages and keys appear on the touch panel display. Operate the machine by directly tapping the displayed keys.
  - (a) Display the home screen
  - (b) Display the job in progress or waiting with text or icon.
  - (c) Select shortcut keys for modes or functions.
  - (d) Switch the pages for displaying shortcut keys.
  - (e) Display Toner Quantity.
  - (f) Display a QR code indicating the web site of the User's Manual.
  - (g) Use these keys to select functions that make the machine easier to use.
  - (h) Switch the pages for displaying shortcut keys.
- (i) Select functions that can be utilized in respective modes. Tap the tab, and the list of function keys is displayed.
- (3) **[System Info.] key**  
Displays information such as the status of the machine, details of errors, and the remaining paper level in the paper feed tray.
- (4) **Main power indicator**  
This lamp lights up when the machine's main power switch is in the "I" position. While the light is blinking, the power cannot be turned on by pressing the [Power] button.
- (5) **[Power] button**  
Use this button to turn the machine's power on and off.
- (6) **NFC touch point area**  
You can easily connect a mobile device to the machine by touching the mobile device.

## Easy Mode and Normal Mode

In the copy, fax and image send modes, there are two types of operation screens: easy mode and normal mode. The easy mode consists of the minimum necessary functions, such as frequently used functions, and most operations can be performed smoothly.

When you want to use detailed settings or special functions, use the normal mode. In normal mode, all functions are available.

(Example: easy mode and normal mode in copy mode)

### Easy mode

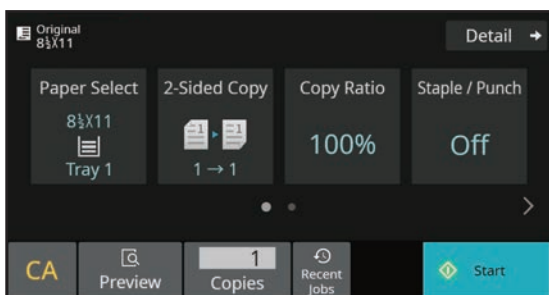

### Normal mode

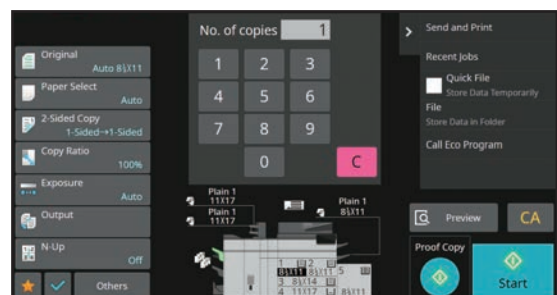





## TO CHANGE THE ANGLE OF THE OPERATION PANEL

You can change the angle of the operation panel.  
Adjust the angle for ease of viewing.

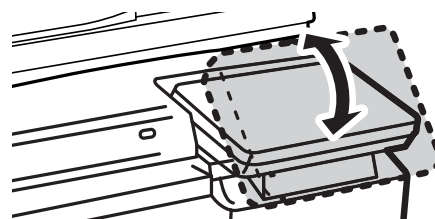

## MOTION SENSOR

This sensor detects the presence of a person that approaches the machine, and automatically wakes the machine from sleep mode (Motion Sensor Mode Only).

Three settings are available for the detection range ( I / II / III ).

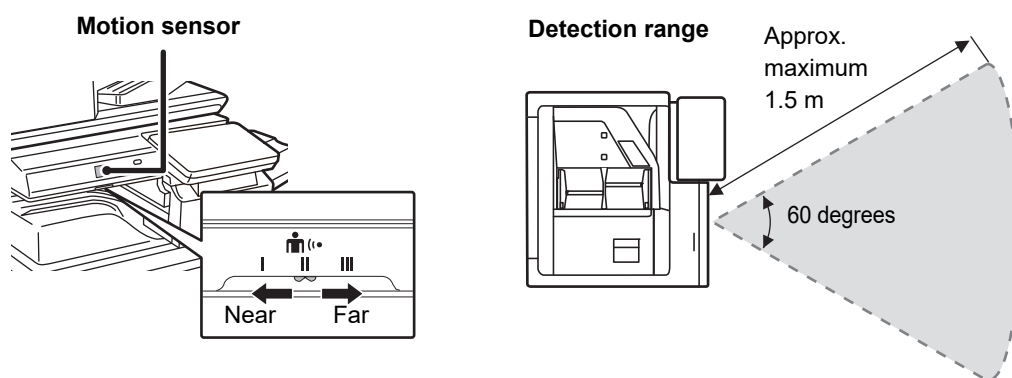

- The motion sensor detects the movement of sources of heat.
- The detection range may vary depending on the installation site and environment (ambient temperature, etc.).



## CHECKING THE STATUS OF A JOB / PRIORITY / CANCELING

To display the Job Status screen, tap the [Job Status] key in the home screen, or tap the [Job Status] key that appears in the upper right corner of each mode screen.

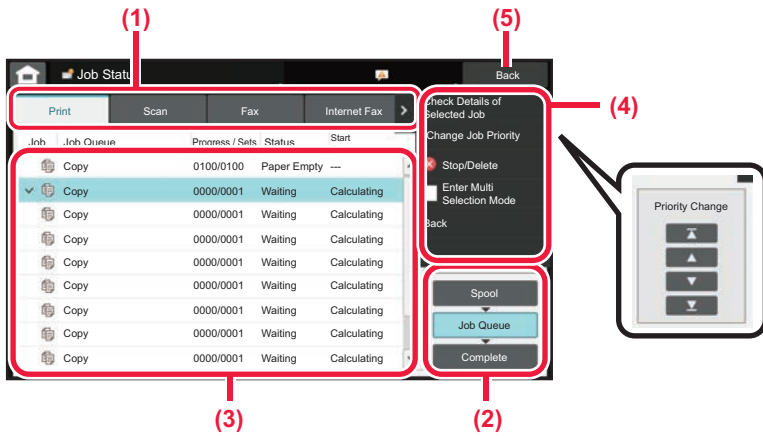

### Check the job status

- Tap the tab of the mode you want to check.**  
Check copy jobs and print jobs on the [Print] tab.
- Tap the [Job Queue] or [Complete] key.**
- Check the jobs in the list.**  
If you want to give a job priority or cancel a job, tap that job.

### To give the job priority

Tap [Change Job Priority], and tap a Change Priority key.

### To cancel the job

If you want to cancel a job, tap that job and tap [Stop/Delete].

## PREVIEW SCREEN

You can tap the [Preview] key to open the Preview screen. In the Preview screen on the touch panel, you can view previews of jobs and images stored in the machine.

### Easy mode

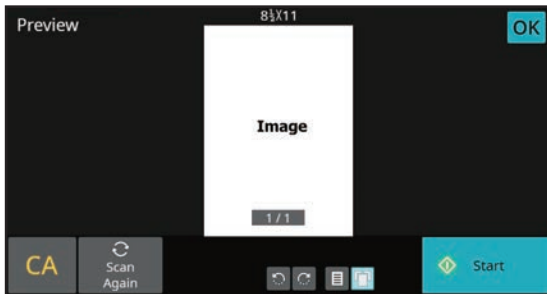

### Normal mode

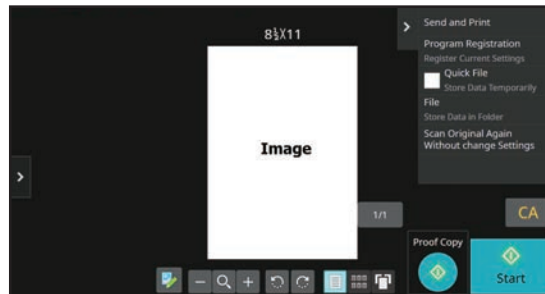



## PLACING ORIGINALS

The automatic document feeder can be used to automatically scan many originals at once, and this saves you the trouble of manually feeding each original.

For originals that cannot be scanned using the automatic document feeder, such as a book or a document with notes attached, use the document glass.

## USING THE AUTOMATIC DOCUMENT FEEDER

When using the automatic document feeder, place the originals in the document feeder tray.

Make sure an original has not been placed on the document glass.

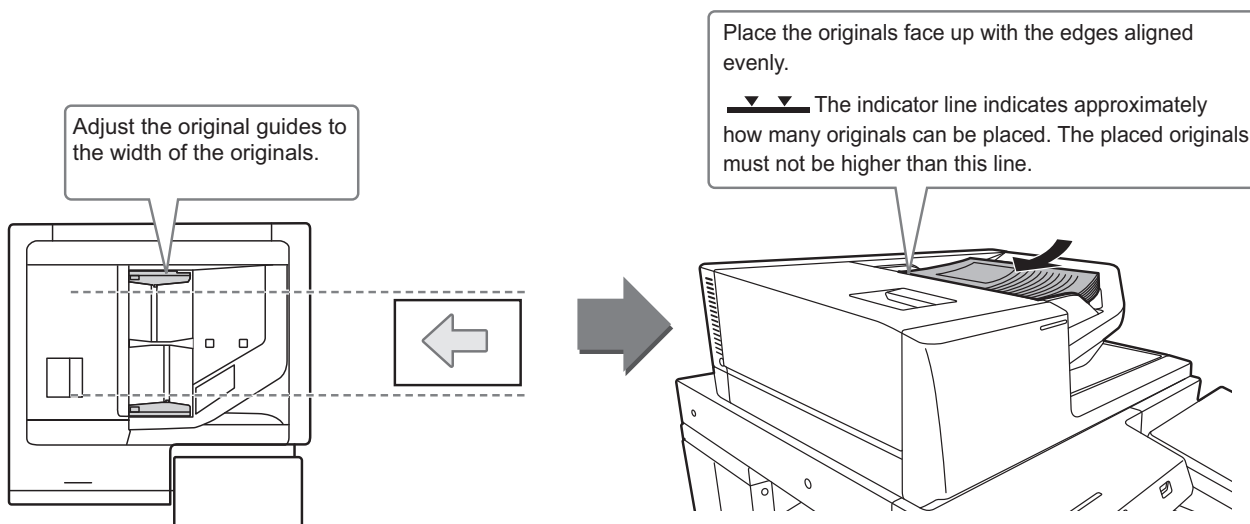

### Loading a Business Card

When scanning a business card with the automatic document feeder, align the original guide to the size of the card.

## USING THE DOCUMENT GLASS

Take care that your fingers are not pinched when closing the automatic document feeder.

After placing the original, be sure to close the automatic document feeder. If left open, parts outside of the original will be copied black, causing excessive use of toner.

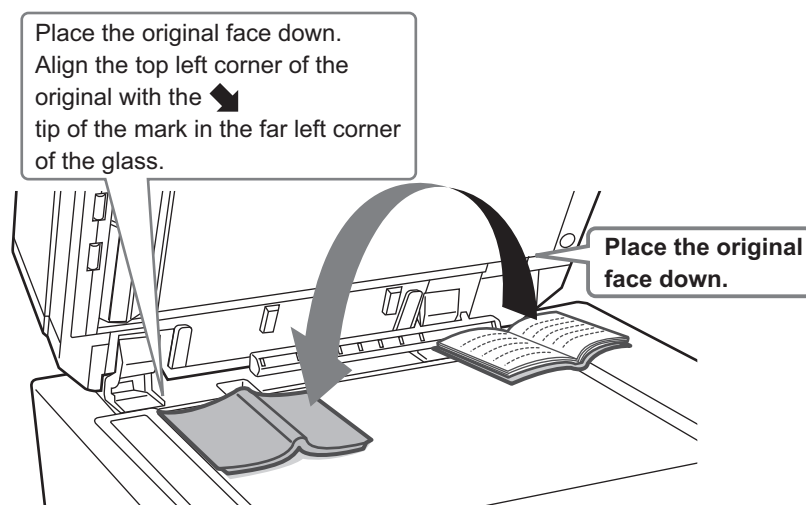

Set the orientation of the image to ensure that the orientation of the placed original is correctly recognized. For details, see the User's Manual.



## ADJUSTING THE VOLUME

You can adjust the volume of sounds generated by the machine. Tap the [Settings] key and configure the following settings from the [System Settings] tab.

(Administrator rights are required.)

▶ [SETTING MODE WHEN AN ADMINISTRATOR IS LOGGED IN \(page 44\)](#)

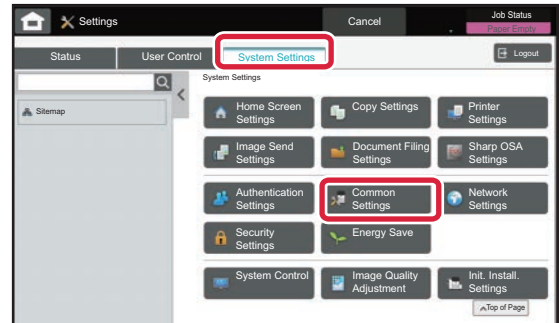
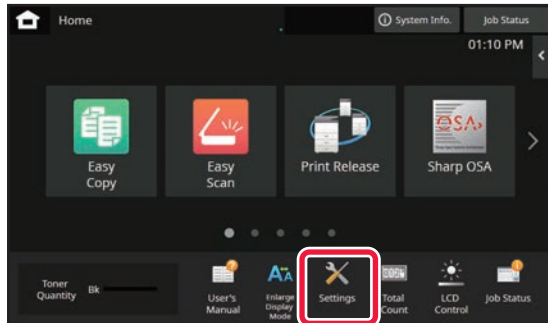

Setting	Settings
Sound Settings → Beep Sound Settings (Common) → Scan Complete Sound (Image Send)	Configure settings for the sound that is generated at the completion of scanning when using the fax, scan, document filing, or other image send function.
Sound Settings → Beep Sound Settings (Image Send) → Fax	For fax, configure settings for the on-hook (speaker) volume, ringing sound, line monitor, reception completed sound, sending completed sound, and send/receive error sound.
Sound Settings → Beep Sound Settings (Image Send) → Internet Fax	Configure settings for sounds generated when an Internet fax is received and when a communication error occurs.
Sound Settings → Beep Sound Settings (Common) → Keys Touch Sound	Configure settings for the sound generated when a key is tapped, and whether a sound is generated when the key for a default setting is tapped.



# LOADING PAPER

## NAMES AND LOCATIONS OF TRAYS

The names of the trays are as follows.

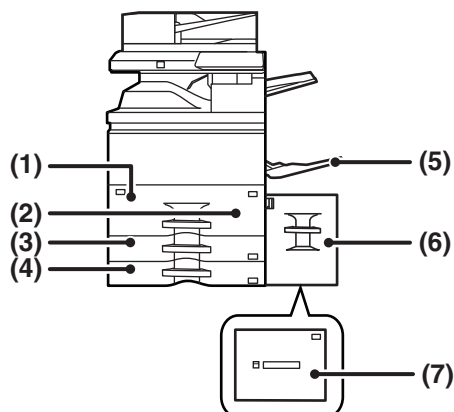

- (1) Tray 1
- (2) Tray 2
- (3) Tray 3
- (4) Tray 4

- (5) Bypass tray
- (6) Tray 5 (BP-LC11)
- (7) Tray 5 (MX-LC19)

### Setting orientation of the print side

The setting orientation varies for the print side of paper, depending on the tray used. For "Letter Head" and "Pre-Printed", set the paper in the reverse orientation.

Place with the print side facing the direction indicated below.

Tray	In normal status	With letter head or pre-printed paper set
Trays 1 - 4	Facing up	Facing down
Bypass tray, Tray 5	Facing down	Facing up

## LOADING PAPER IN THE TRAY 1/2

1

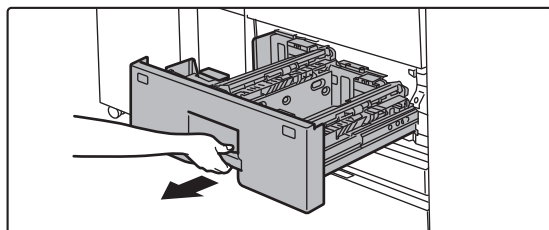

### Pull out the paper tray.

Gently pull the tray out until it stops.



Keep holding the handle until the lock is released.



## BEFORE USING THE MACHINE

2

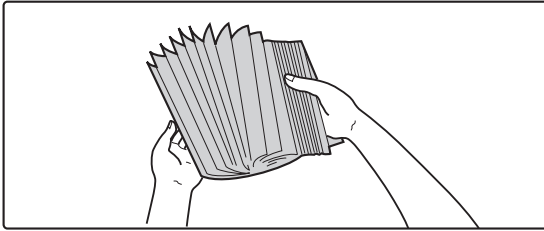

### Fan the paper.

Fan the paper well before loading it. If the paper is not fanned, multiple sheets may feed at once and cause a misfeed.

3

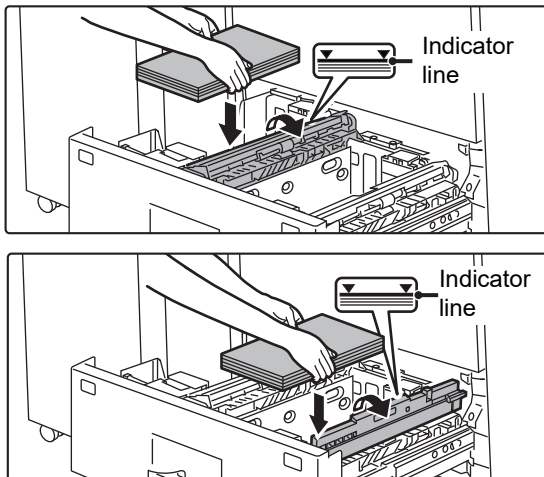

### Lift the feed roller, and place paper into the tray.

Load the paper with the print side facing up. The stack must not be higher than the indicator line (maximum of 1250 sheets for tray 1, or maximum of 850 sheets for tray 2). Do not load the paper as shown below.



4

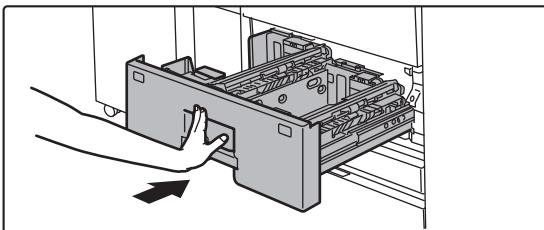

### Lower the feed roller, and gently push the paper tray into the machine.

Push the tray firmly all the way into the machine slowly. Forcefully inserting the paper may cause skewed feeding and paper misfeeds.

## LOADING PAPER IN THE TRAY 3/4

1

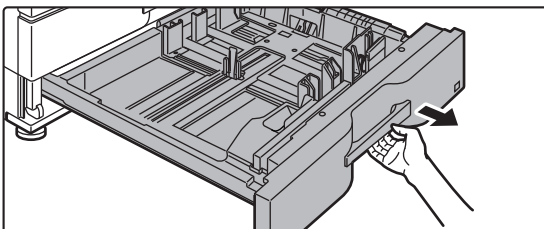

### Pull out the paper tray.

Gently pull the tray out until it stops.

To load paper, go to step 3.

To load a different size of paper, go to the next step.



Keep holding the handle until the lock is released.



2

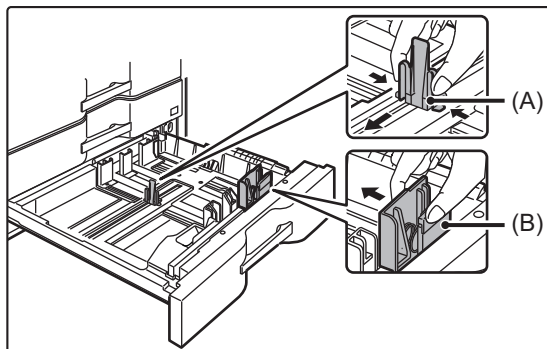

**Adjust guide plates A and B by squeezing their lock levers and sliding them to match the longitudinal and transversal dimensions of the paper to be loaded.**

The guide plates A and B are slidable. Slide each guide plate while squeezing its lock lever to adjust to the paper size.

Do not load the paper as shown below.



A non-standard size of paper can only be loaded in tray 4. A non-standard size of paper cannot be loaded in tray 3.

3

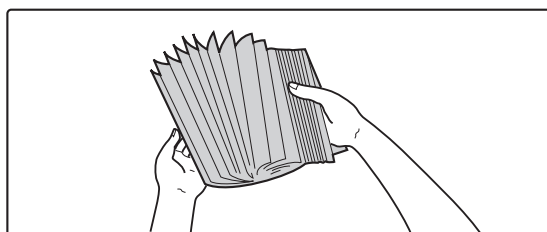

**Fan the paper.**

Fan the paper well before loading it. If the paper is not fanned, multiple sheets may feed at once and cause a misfeed.

4

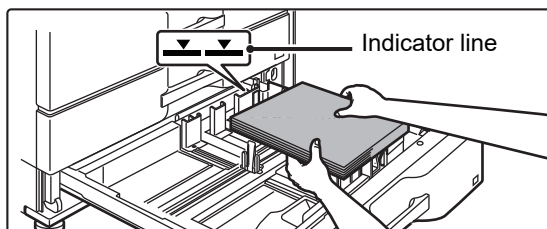

**Insert the paper into the tray.**

Load the paper with the print side facing up. The stack must not be higher than the indicator line (maximum of 500 sheets).

5

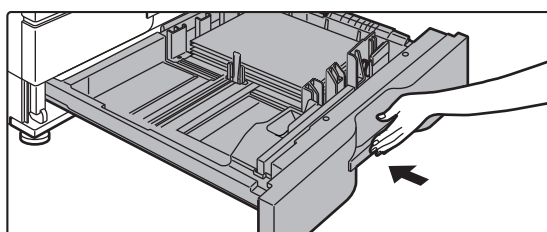

**Gently push the paper tray into the machine.**

Push the tray firmly all the way into the machine slowly. Forcefully inserting the paper may cause skewed feeding and paper misfeeds.



## LOADING PAPER IN OTHER TRAYS

### Bypass tray

1

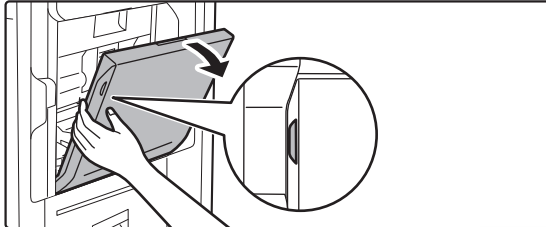

Open the bypass tray.

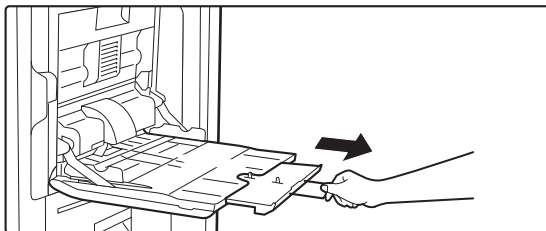

When loading paper larger than 8-1/2" x 11"R or A4R, pull out the extension guide. Pull the extension guide all the way out.

2

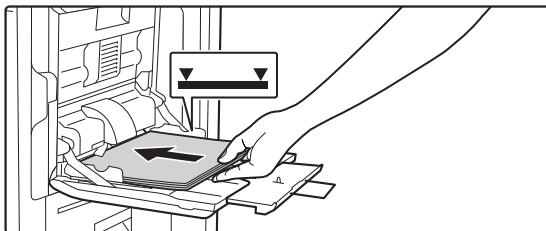

**Load the paper with the print side facing down.**

Insert the paper along the bypass tray guides all the way into the bypass tray until it stops slowly. Inserting the paper with excessive force may cause the leading edge to fold back. Inserting the paper too loosely may cause skewed feeding or misfeeds. The paper must not exceed the maximum number of sheets and must not be higher than the indicator line.

3

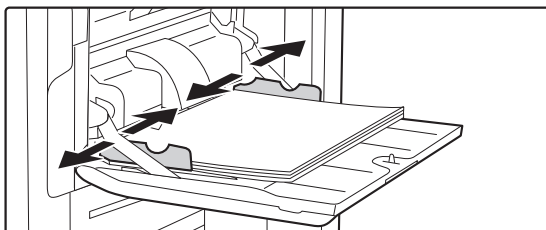

**Set the bypass tray guides correctly to the width of the paper.**

Adjust the bypass tray guides so that they slightly contact the loaded paper.





## Large capacity tray (BP-LC11)

When changing the paper size, consult the dealer or nearest authorised service representative.

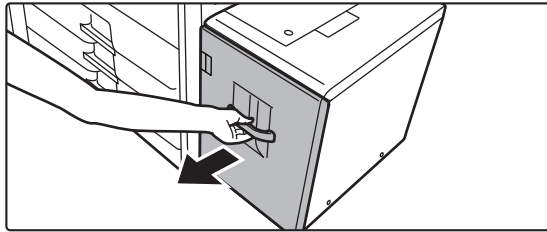
**1**

### Pull out the paper tray.

Gently pull the tray out until it stops.

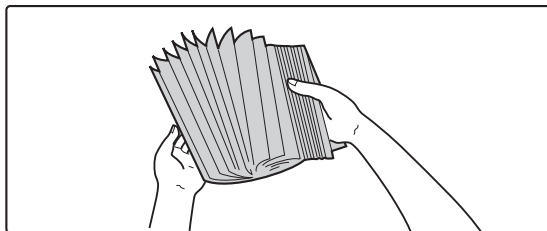
**2**

### Fan the paper.

Fan the paper well before loading it. If the paper is not fanned, multiple sheets may feed at once and cause a misfeed.

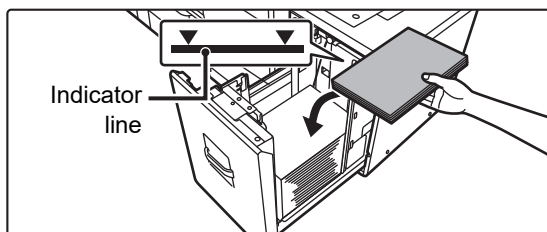
**3**

### Place the paper in the center of the paper table.

Load the paper with the print side facing up. The stack must not be higher than the indicator line (maximum of 3500 sheets).

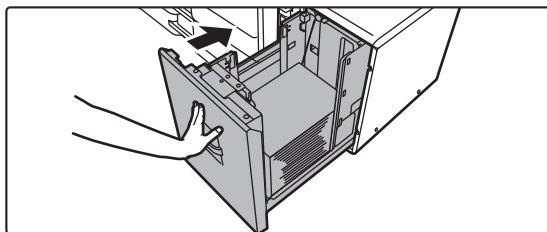
**4**

### Gently push the paper tray into the machine.

Push the tray firmly all the way into the machine slowly. Forcefully inserting the paper may cause skewed feeding and paper misfeeds.





## Large capacity tray (MX-LC19)

1

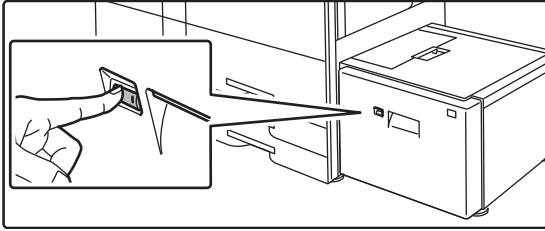

### Press the operation button.

The operation button blinks, and the tray paper table goes down to the paper loading position. Wait until the operation button light goes off.



Do not pull out the tray until the light goes off. If you pull out the tray forcibly while the button lights up or blinks, a machine failure may be resulted.

2

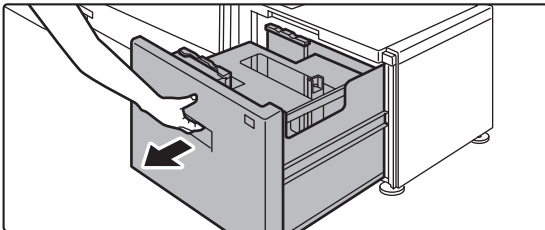

### Pull out the paper tray.

Gently pull the tray out until it stops.

3

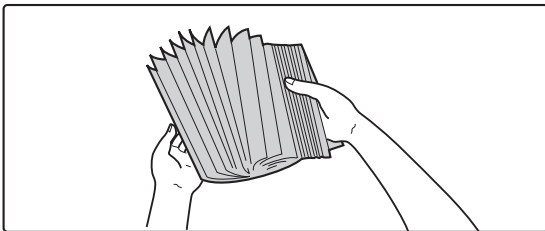

### Fan the paper.

Fan the paper well before loading it. If the paper is not fanned, multiple sheets may feed at once and cause a misfeed.

4

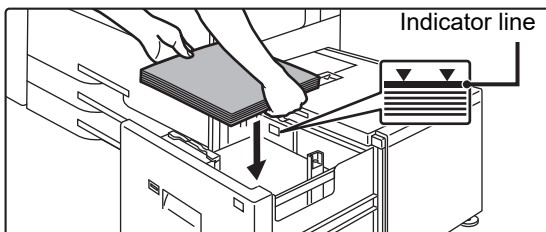

### Place the paper in the center of the paper table.

Load the paper with the print side facing up. The stack must not be higher than the indicator line (maximum of 3000 sheets).

When a certain volume of paper is loaded, the paper table automatically goes down slightly and stops. Repeat this operation in the same way to load paper.



- Do not insert your hand into the space inside the paper table when you load paper.

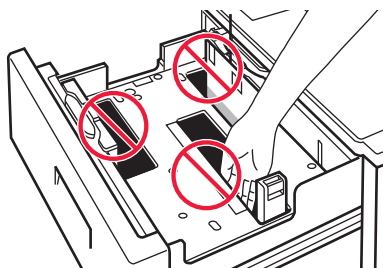

- Do not insert spare paper or objects into the space inside the tray.

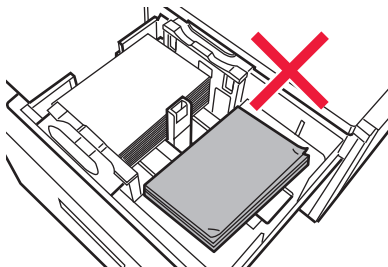

5

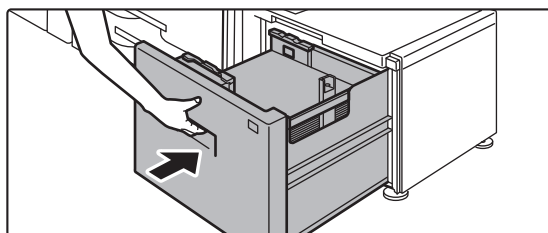

### **Gently push the paper tray into the machine.**

Push the tray firmly all the way into the machine slowly. Forcefully inserting the paper may cause skewed feeding and paper misfeeds.

The paper table goes up after the tray is pushed in. The operation button blinks while the paper table goes up. The button lights up when the paper table has gone up.



## CHANGE THE SETTING OF THE PAPER TRAY

To change the paper loaded in the tray, change the machine's tray settings from the [Tray Settings] key in the home screen.

As an example, the steps for changing the paper in tray 3 from 8-1/2" x 14" plain paper to 8-1/2" x 11" recycled paper are explained below.

1



Tap the [Home Screen] key.

Home screen appears.

2

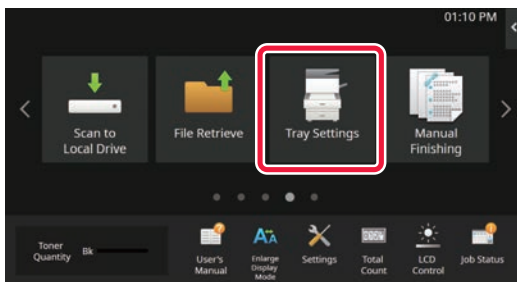

Tap the [Tray Settings] key and tap the key of the paper tray 3.

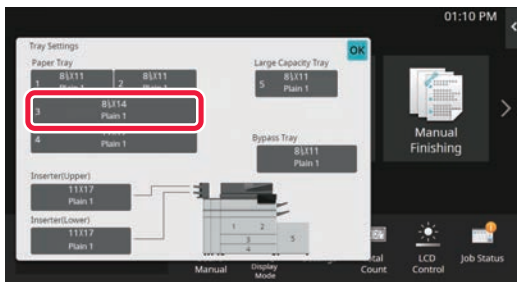

3

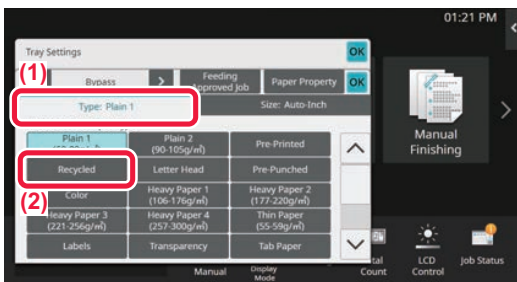

Set the paper type.

(1) Tap the tab for the Paper Type.

(2) Tap the [Recycled] key.

4



Set the paper size.

(1) Tap the tab for the Paper Size.

(2) Tap the [Auto-Inch] key.

(3) Tap **OK** in "Tray Settings".



# SAVING CONTACTS IN THE ADDRESS BOOK

"Contacts" and "Group" can be stored in the address book.

The procedure for adding a new contact to the address book by directly entering the name and address is explained here as an example.

1



Tap the [Home Screen] key.

Home screen appears.

2

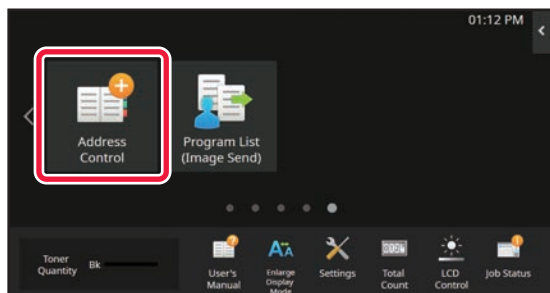

Tap the [Address Control] key.

3

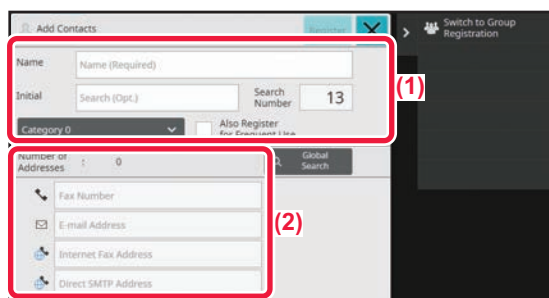

Enter the information you want to register in the address book.

(1) Enter basic information.

Be sure to enter [Name] and [Initial].

To specify a category, select one from a category list that appears when the entry box is tapped.

To register a contact for frequent use, select the [Also Register for Frequent Use] checkbox .

(2) Tap [Fax Number], [E-mail Address], [Internet Fax Address], or [Direct SMTP Address], enter the address, and tap **OK**.

4

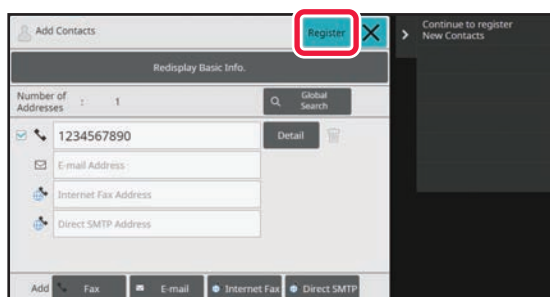

Tap the [Register] key.

The first address of each address type is set as the default address. If no address has the checkbox next to it selected, a confirmation screen will appear asking you if you want to select a default address.

## Editing or deleting a contact

Tap the [Address Book] key in the home screen, select the contact to be edited or deleted, tap  in the action panel, and tap [Edit] or [Delete].

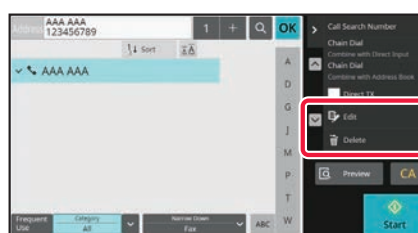
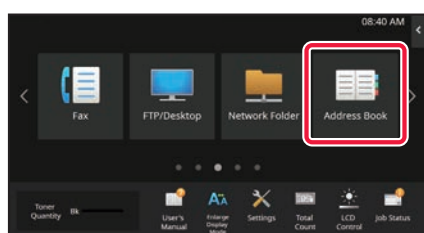



## ACCESSING THE WEB SERVER IN THE MACHINE

When the machine is connected to a network, the machine's built-in Web server can be accessed from a Web browser on your computer.

### OPENING THE WEB PAGES

1

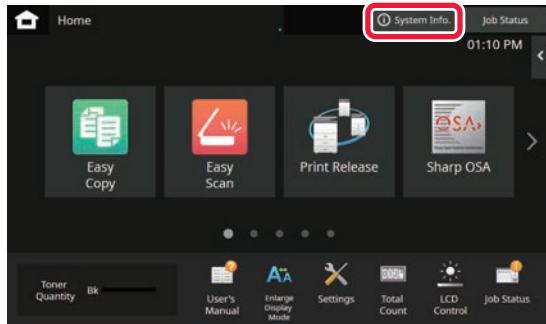

Tap the [System Info.] key.

2

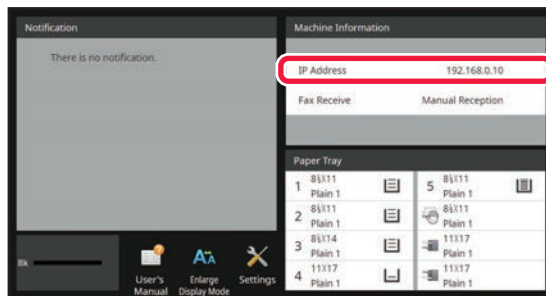

Check the IP address in the machine information.

3

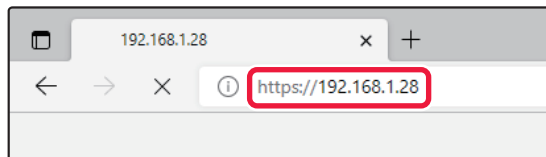

Access the Web server in the machine to open the Web pages.

Start a Web browser on a computer that is connected to the same network as the machine and enter the IP address of the machine.

The Web page will appear.

The machine settings may require that user authentication is performed in order to open the Web page. Please ask the administrator of the machine for the password that is required for user authentication.

Recommended Web browsers

Microsoft Edge (Windows®), Firefox (Windows®),

Safari (macOS®), Chrome (Windows®):

Latest version or immediately previous major release



# USER AUTHENTICATION

When user authentication is enabled in settings mode, you must log in in order to use the machine. User authentication is disabled in the factory default settings.

When you have finished using the machine, log out.

## ABOUT AUTHENTICATION METHODS

There are three user authentication methods: authentication by user number, authentication by login name / password, and authentication by quick authentication. Ask the system administrator of the machine for the information you need to log in.

### AUTHENTICATION BY USER NUMBER

The following procedure is used to log in using a user number received from the administrator of the machine.

When starting the machine, the login screen appears.

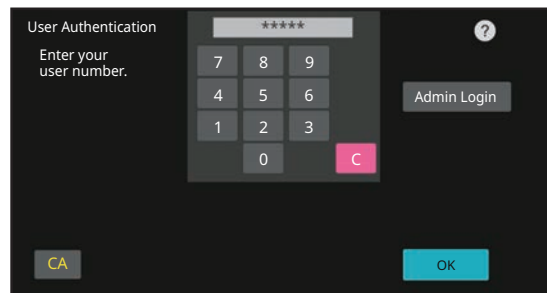

### AUTHENTICATION BY LOGIN NAME/PASSWORD

This method enables users to log in using a login name and password received from the administrator of the machine or the administrator of the LDAP server.

When starting the machine, the login screen appears.

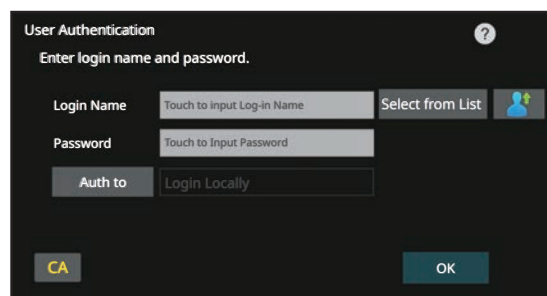

### AUTHENTICATION BY QUICK AUTHENTICATION

This can only be used on the machine when carrying out user authentication. This method provides simple authentication for an administrator who has been previously registered on the machine.

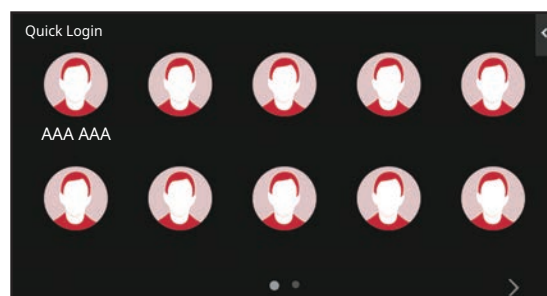

## LOGOUT

When you have finished using the machine, log out. This helps prevent unauthorized people from using the machine.

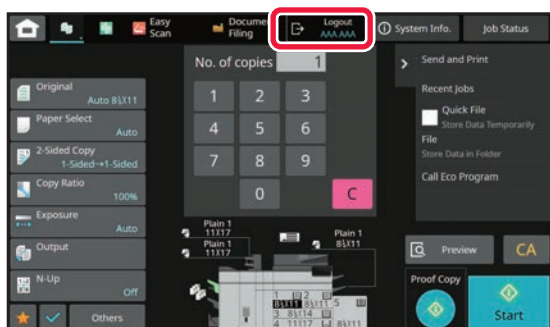



## FUNCTIONS THAT CAN BE USED ON THE MACHINE

The machine has many functions for a variety of purposes.

Some convenient functions are described in below. For details, see the User's Manual.

### N-Up



This function uniformly lays out multiple original pages onto a single sheet of paper.

This function is convenient when you wish to present multiple pages in a compact format, or show a view of all pages in a document.

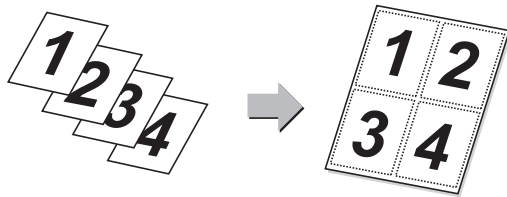

### Blank Page Skip



If the scanned original contains blank pages, this function skips them to copy or send only non-blank pages.

The machine detects blank pages, enabling you to skip useless blank sheets without checking an original.

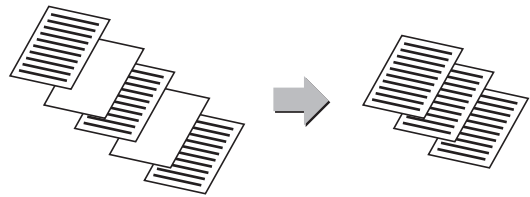

### Multi-crop scan / Image Crop



You can place multiple documents such as receipts or photographs on the document glass, and automatically crop and save each document to a separate file during scanning.

#### Multi crop

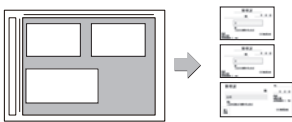

#### Image Crop

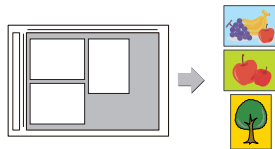

### Auto Set



To automatically set scan settings appropriate for the original, tap the [Auto Set] key in the base screen of Easy Mode.

Image Orientation, Resolution, and Blank Page Skip, Duplex Setup, Skew Adjustment, JPEG Compression Ratio, Automatically Detect Mono2/Grayscale are set automatically.

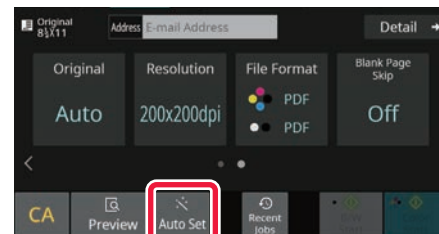

### Slow Scan Mode



Use this function when you wish to scan thin originals using the automatic document feeder. This function helps prevent thin originals from misfeeding.

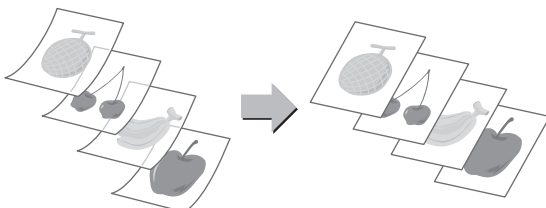

### Dual Page Scan



The left and right sides of an original can be transmitted as two separate pages. This function is useful when you wish to fax the left and right pages of a book or other bound document as separate pages.

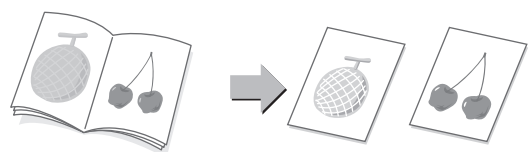





# COPIER

This section explains the basic procedures for using the copier function.

## MAKING COPIES

This section explains how to set a Copy Ratio.

1



**Tap the [Home Screen] key.**

Home screen appears.

2

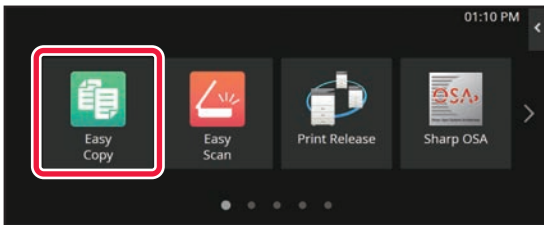

**Tap the [Easy Copy] mode icon.**

Easy Copy mode screen appears.

Copy mode has two modes: easy mode and normal mode. Easy mode is limited to frequently used functions that allow you to smoothly perform most copy jobs.

If you need to select detailed settings or special functions, use normal mode. All functions can be used in normal mode.

3

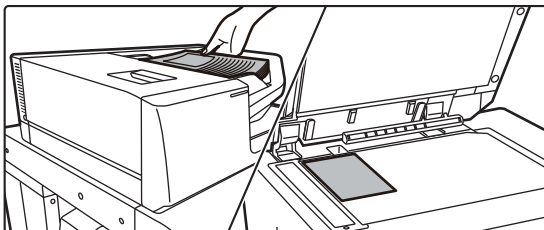

**Place the original.**

Place the original in the document feeder tray of the automatic document feeder, or on the document glass.

► [PLACING ORIGINALS \(page 11\)](#)



4

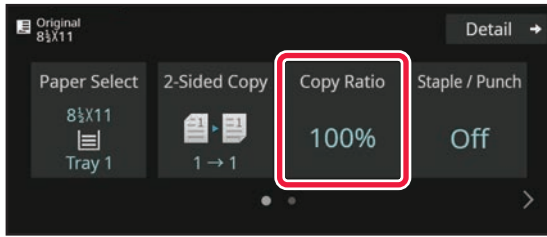

## Tap the [Copy Ratio] key.

The functions below can be enabled in easy mode.

- Paper Select
- 2-Sided Copy
- Copy Ratio
- Staple\*1, Staple / Punch\*2
- Original
- Exposure
- N-Up
- Card Shot
- Job Build
- Blank Page Skip
- Dual Page Copy

\*1 When a finisher, finisher (large stacker), saddle stitch finisher or saddle stitch finisher (large stacker) is installed.

\*2 When a punch module and finisher, finisher (large stacker), saddle stitch finisher or saddle stitch finisher (large stacker) is installed.

To select more detailed settings, tap the [Detail] key and select settings in normal mode.

5

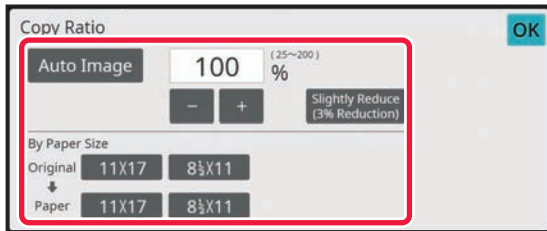

## Set the copy ratio.

After the settings are completed, tap [OK].

6

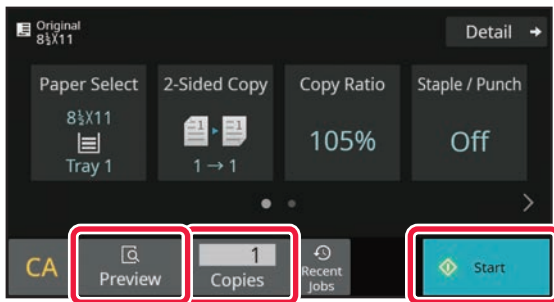

## Set the number of copies and then tap the [Start] key.

- To check a preview of a document, tap the [Preview] key.
  - ▶ [PREVIEW SCREEN \(page 10\)](#)

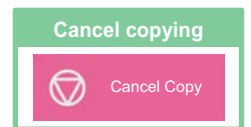



# COPYING ON SPECIAL PAPER (Bypass Copy)

This section explains how to load 8-1/2" x 11" heavy paper in the bypass tray.

1

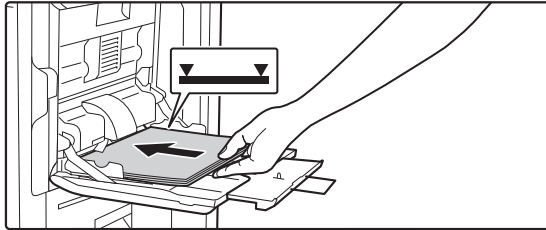

**Load paper into the bypass tray.**

► [Bypass tray \(page 16\)](#)

2

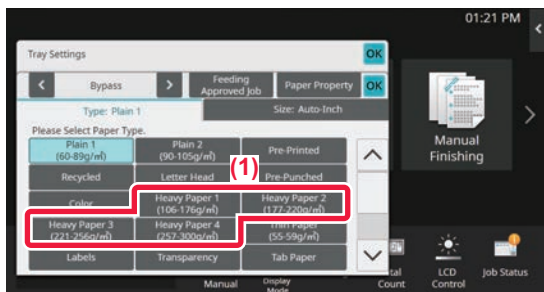

**Select settings in the touch panel.**

(1) Tap the [Heavy Paper 1], [Heavy Paper 2], [Heavy Paper 3] or [Heavy Paper 4] key.

Tap the [Heavy Paper 1] key if the paper is 28 lbs. bond to 65 lbs. cover (106 g/m<sup>2</sup> to 176 g/m<sup>2</sup>), the [Heavy Paper 2] key if the paper is 65 lbs. cover to 80 lbs. cover (177 g/m<sup>2</sup> to 220 g/m<sup>2</sup>), the [Heavy Paper 3] key if the paper is 80 lbs. index to 140 lbs. index (221 g/m<sup>2</sup> to 256 g/m<sup>2</sup>), or the [Heavy Paper 4] key if the paper is 140 lbs. index to 110 lbs. cover (257 g/m<sup>2</sup> to 300 g/m<sup>2</sup>).

(2) Tap the [Size: Auto-Inch] tab.

(3) Tap the [Auto-Inch] key.

(4) Tap [OK] of "Tray Settings".



3

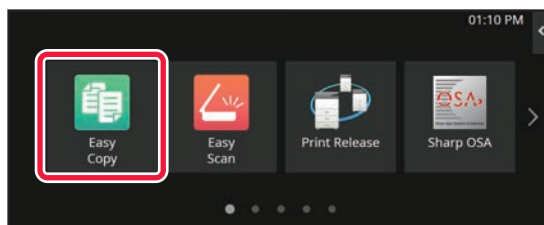

**Tap the [Easy Copy] mode icon.**

Easy Copy mode screen appears.



4

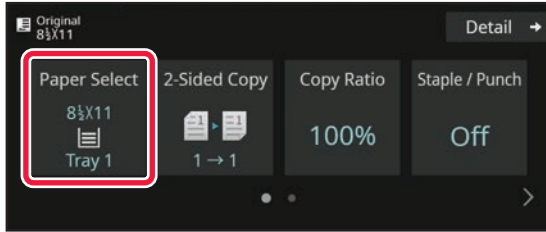

Tap the [Paper Select] Key.

5

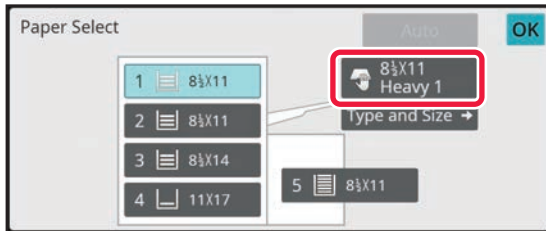

Select the Bypass Tray.

6

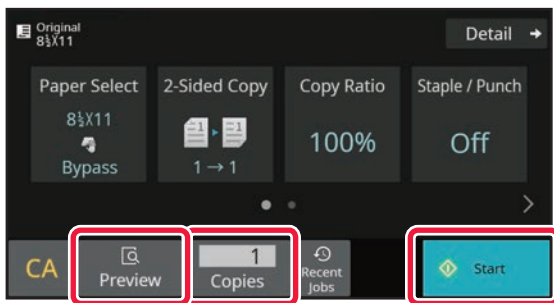

Set the number of copies and then tap the [Start] key.

- To check a preview of a document, tap the [Preview] key.
- ▶ [PREVIEW SCREEN \(page 10\)](#)

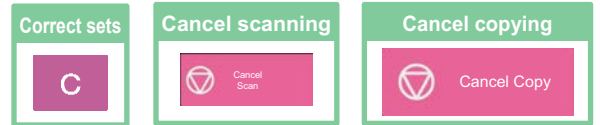



# PRINTER

This section explains the basic procedure for printing using the printer driver of the machine. The explanations of screens and procedures are primarily for Windows® 10 in Windows® environments, and macOS 11 in macOS environments. The window varies depending on the operating system version, the printer driver version, and the application.

## PRINTING IN A WINDOWS ENVIRONMENT

The following example explains how to print an A4 size document from "WordPad", which is a standard accessory program in Windows.

To install the printer driver and configure settings in a Windows environment, see the Software Setup Guide. For information on the available printer drivers and the requirements for their use, see the User's Manual.

1

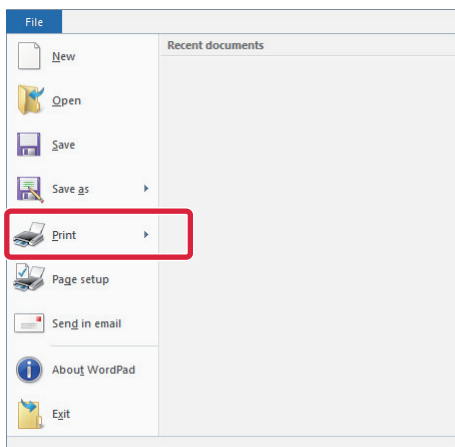

Select [Print] from the [File] menu of WordPad.

2

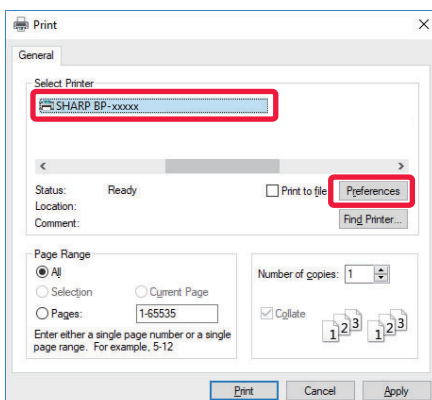

Select the machine's printer driver, and click the [Preferences] button.

If the printer drivers appear as a list, select the name of the printer driver to be used from the list.



3

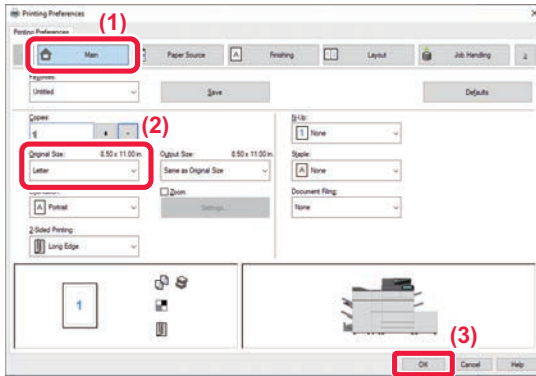

## Select print settings.

(1) Click the [Main] tab.

(2) Select the original size.

To select settings on other tabs, click the desired tab and then select the settings.

(3) Click the [OK] button.

- Help can be displayed for a setting by clicking the setting and pressing the [F1] key.
- Click the [Help] button, the Help window will open to let you view explanations of the settings on the tab.

4

## Click the [Print] button.

Printing begins.



# PRINTING IN A macOS ENVIRONMENT

The following example explains how to print an A4 size document from "TextEdit", which is a standard accessory program in macOS.

To install the printer driver and configure settings in a macOS environment, see the Software Setup Guide.

1

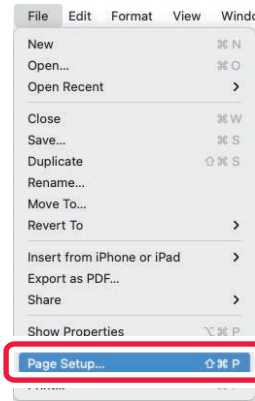

Select [Page Setup] from the [File] menu.

2

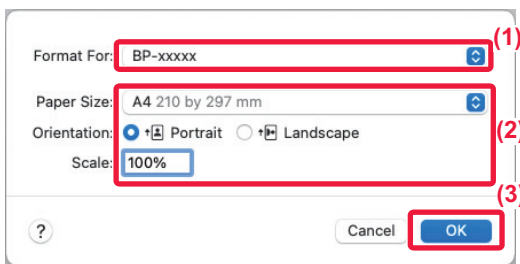

Select paper settings.

- (1) Make sure that the correct printer is selected.
- (2) Select the paper settings.  
Set the paper size, paper orientation, and copy ratio.
- (3) Click the [OK] button.

3

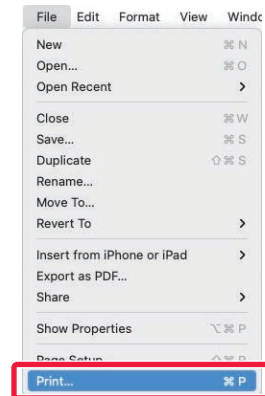

Select [Print] from the [File] menu.





## 4

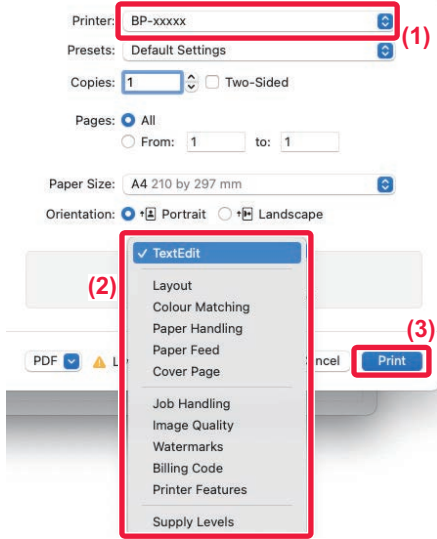

### Select print settings.

- (1) Make sure that the correct printer is selected.
- (2) Select items from the menu and configure the settings as needed.
- (3) Click the [Print] button.





# DIRECTLY PRINTING A FILE IN USB MEMORY

Files in a USB memory device connected to the machine are printed from the operation panel of the machine without using the printer driver.

The file types (and corresponding extensions) that can be printed directly are shown below.

File Type	TIFF	JPEG	PCL	PDF/EncryptedPDF/Compact PDF	PS	DOCX, XLSX, PPTX	PNG
Extension	tiff, tif	jpeg, jpg, jpe, jfif	pcl, prn	pdf	ps, prn	docx, xlsx, pptx	png

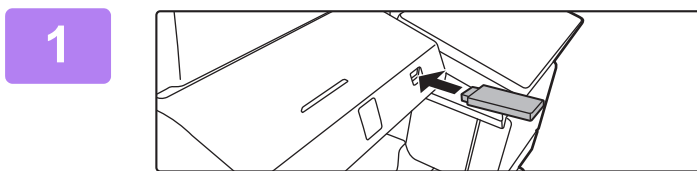

**1 Connect the USB memory device to the machine.**

- Use FAT32, NTFS or exFAT format for USB memory device.
- When the format of the USB memory device is FAT32, use a 32 GB or less USB memory device.

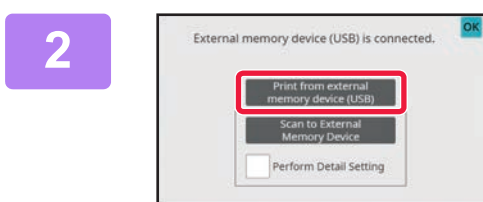

**2 When a screen for selecting the action appears, tap [Print from external memory device (USB)].**

If the screen does not appear, follow these steps:

- (1) Tap the [File retrieve] key.
- (2) Tap [Select File from USB Memory to Print] on the action panel.

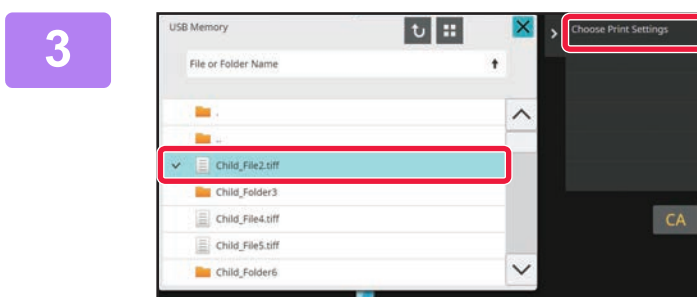

**3 Tap the key of the file that you wish to print, and tap [Choose Print Settings] on the action panel.**

- When printing multiple files, tap the keys of the files you wish to print, and tap [Print] on the action panel.
- Tap to switch to thumbnails.



**4 Select print settings and tap the [Start] key.**

**5 Remove the USB memory device from the machine.**

Qualcomm® DirectOffice™ is a product of Qualcomm Technologies, Inc. and/or its subsidiaries. Qualcomm® is a trademark of Qualcomm Incorporated, registered in the United States and other countries.

DirectOffice™ is a trademark of CSR Imaging US, LP, registered in the United States and other countries.



# FACSIMILE

This section explains the basic procedures for using the fax function of the machine.

## SENDING A FAX

This section explains the basic procedure for sending a fax.  
In fax mode, color originals are sent as black and white images.

1



**Tap the [Home Screen] key.**

Home screen appears.

2

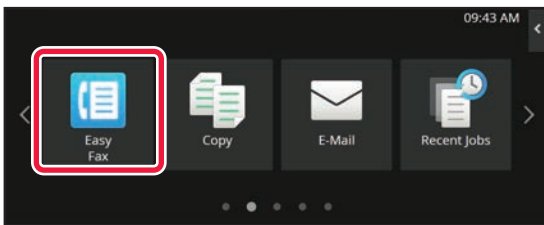

**Tap the [Easy Fax] mode icon.**

Easy Fax mode screen appears.

Fax mode has two modes: easy mode and normal mode. Easy mode is limited to frequently used functions that allow you to smoothly perform most fax jobs.

If you need to select detailed settings or special functions, use normal mode.

▶ [Easy Mode and Normal Mode \(page 8\)](#)

3

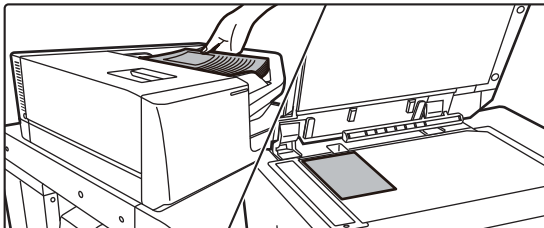

**Place the original.**

Place the original in the document feeder tray of the automatic document feeder, or on the document glass.

▶ [PLACING ORIGINALS \(page 11\)](#)

4

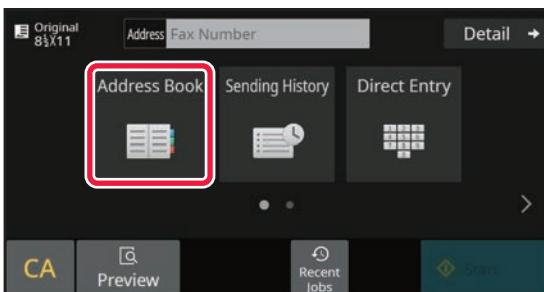

**Tap the [Address Book] key.**

You can also select a fax number from the Sending History, or tap the [Direct Entry] key to directly enter a fax number.



5



### Tap the key of the desired destination.

Addresses of the current mode are selected from addresses whose checkboxes were selected when the tapped destination was registered. If no addresses were registered with the checkbox selected, tap the [Yes] key in the confirmation screen and select the desired addresses. To add another destination, tap the key of the destination.

6

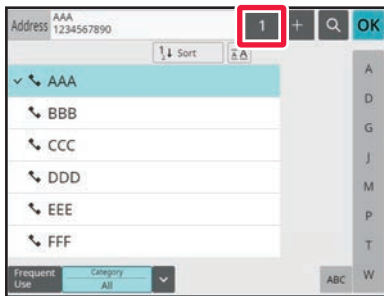

### Tap the [All Destinations] key.

A list of the selected destinations appears.

7

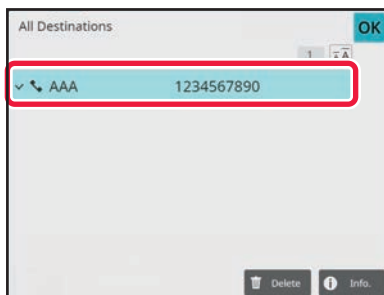

### Confirm the destination.

If an incorrect destination appears in the list, tap the destination and then tap the [Delete] key.

8

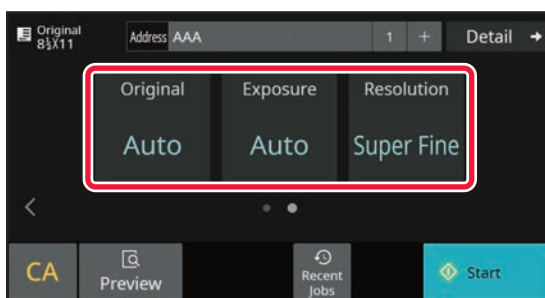

### Tap **>** to change screens and select settings.

Change settings as needed.

The functions below can be enabled in easy mode.

- Original set
- Exposure
- Resolution

To select more detailed settings, tap the [Detail] key and select settings in normal mode.

▶ [Easy Mode and Normal Mode \(page 8\)](#)

9

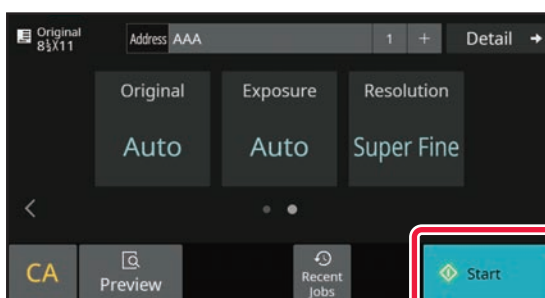

### Tap the [Start] key.

To check a preview of a document, tap [OK] to return to the base screen of Easy Fax and tap the [Preview] key.

▶ [PREVIEW SCREEN \(page 10\)](#)

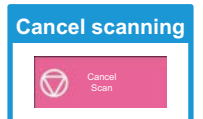



# SCANNER

This section explains the uses of the network scanner function and the basic procedure for using scan mode. The Internet fax expansion kit is required to use the Internet fax function.

## NETWORK SCANNER FUNCTION

The network scanner function of the machine can be used to transmit scanned images by a variety of methods. The network scanner function has the following modes.

To use a mode, tap the button of the mode in the home screen.

If the button you want to use does not appear, tap or to change the screen.

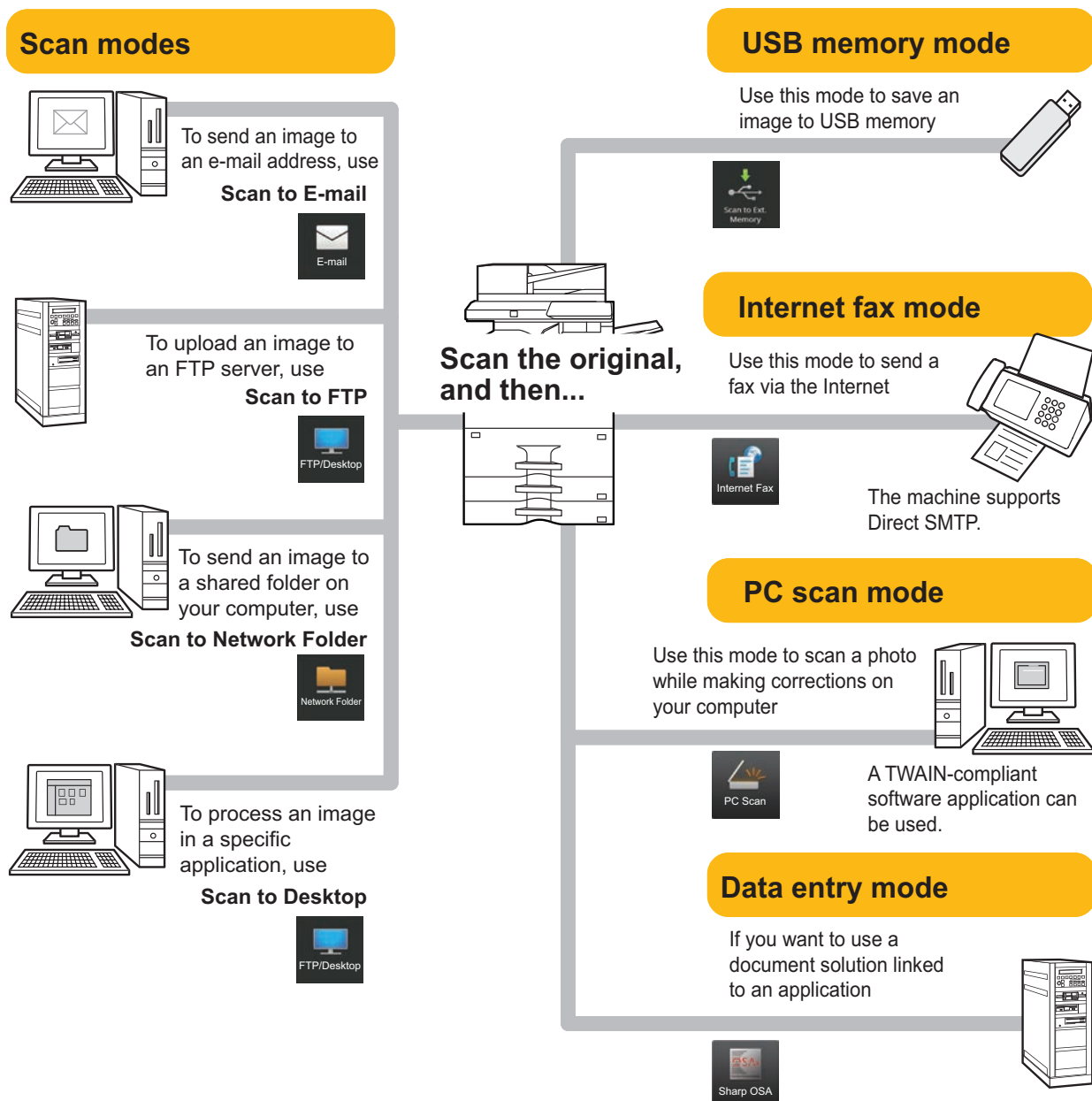



# SCANNING AN ORIGINAL

The basic operation for scanning is explained below.

The procedure for sending a scanned file by E-mail to a destination stored in the address book is explained here.

1



## Tap the [Home Screen] key.

Home screen appears.

2

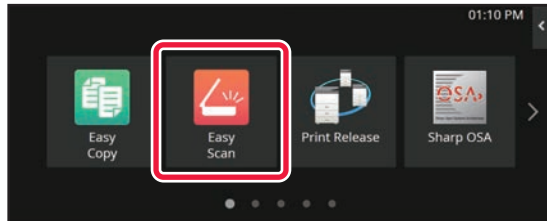

## Tap the [Easy Scan] mode icon.

Easy Scan mode screen appears.

Scanner mode has two modes: easy mode and normal mode.

Easy mode is limited to frequently used functions that allow you to smoothly perform most scan jobs.

If you need to select detailed settings or special functions, use normal mode.

▶ [Easy Mode and Normal Mode \(page 8\)](#)

3

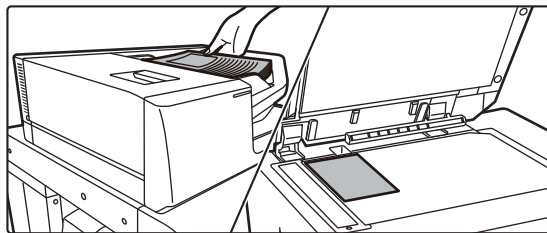

## Place the original.

Place the original in the document feeder tray of the automatic document feeder, or on the document glass.

▶ [PLACING ORIGINALS \(page 11\)](#)

4

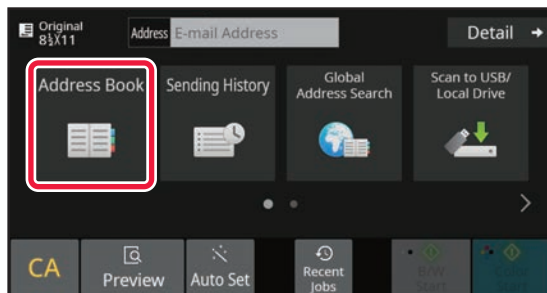

## Tap the [Address Book] key.

5

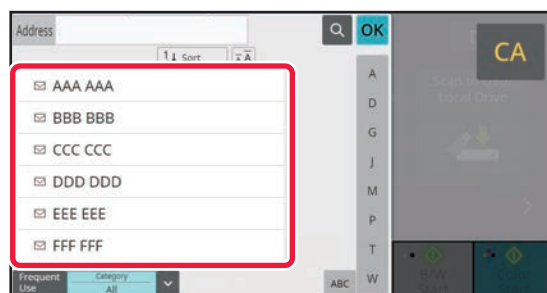

## Tap the key of the desired destination.

Addresses of the current mode are selected from addresses whose checkboxes were selected when the tapped destination was registered. If no addresses were registered with the checkbox selected, tap the [Yes] key in the confirmation screen and select the desired addresses.

To add another destination, tap the key of the destination.



6

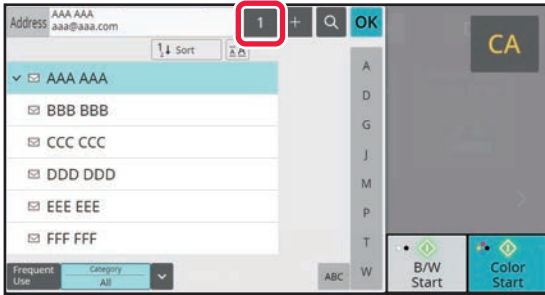

### Tap the [All Destinations] key.

A list of the selected destinations appears.

7



### Confirm the destination.

If an incorrect destination appears in the list, tap the destination and then tap the [Delete] key.

8

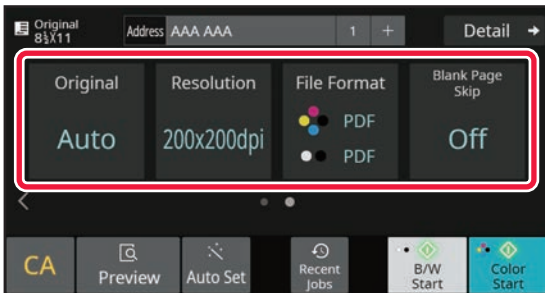

### Tap to change screens and select settings.

Change settings as needed.

The functions below can be enabled in easy mode.

- Original
- Resolution
- File Format
- Blank Page Skip

To select more detailed settings, tap the [Detail] key and select settings in normal mode.

▶ [Easy Mode and Normal Mode \(page 8\)](#)

9

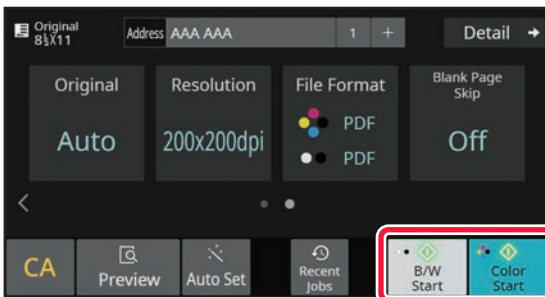

### Tap the [Color Start] key or [B/W Start] key.

- In the factory default state, the machine detects whether the original is black & white or full color when you tap the [Color Start] key, and automatically switches between full color and black & white binary scanning. When you tap the [B/W Start] key, the machine scans in black & white binary. For details, see the User's Manual.

- To check a preview of a document, tap [OK] to return to the base screen of Easy Scan and tap the [Preview] key.

▶ [PREVIEW SCREEN \(page 10\)](#)

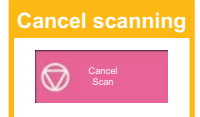



# DOCUMENT FILING

The document filing function is used to store the document or print image on the hard drive when performing a copy, print, or other job. You can print or perform other operations using the saved file at a later time. This section introduces several of the document filing functions.

## SAVING A DOCUMENT ONLY (Scan to Local Drive)

Scan to Local Drive lets you save a scanned document to the main folder or a custom folder. This function is not used to print or send.

The procedure for storing a document in the main folder is explained below.

To save to a custom folder, tap the [File retrieve] key in the Home screen, tap [Scan to Local Drive] on the action panel, and select save settings. For more information, see the User's Manual.

### Saving by Easy Scan

You can save a file in the main folder or My Folder (when user authentication is enabled).

1



**Tap the [Home Screen] key.**

The Home screen appears.

2

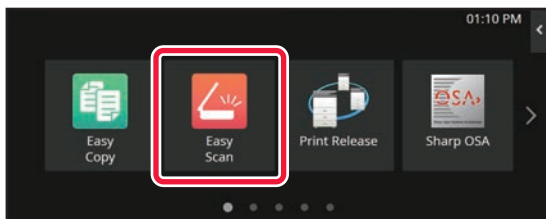

**Tap the [Easy Scan] mode icon.**

3

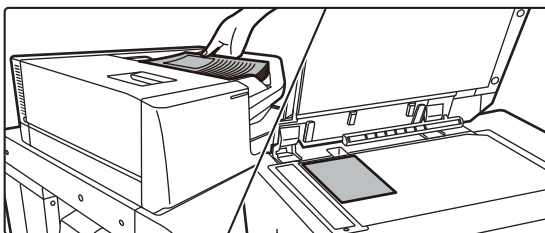

**Place the original.**

Place the original in the document feeder tray of the automatic document feeder, or on the document glass.

▶ [PLACING ORIGINALS \(page 11\)](#)



4

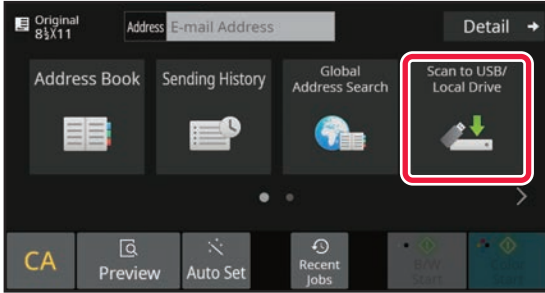

Tap the [Scan to USB/Local Drive] key.

5

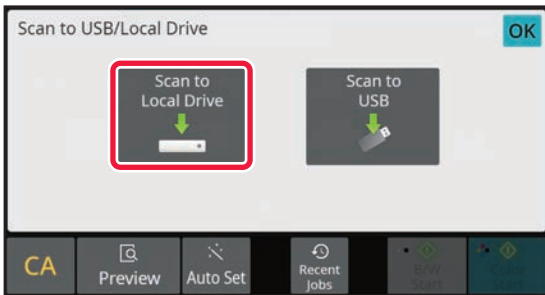

Tap the [Scan to Local Drive] key.

6

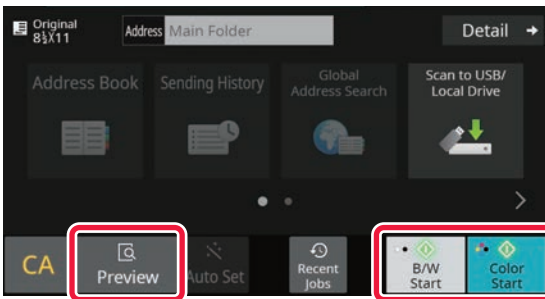

Tap the [Color Start] key or [B/W Start] key.

To check a preview of a document, tap the [Preview] key.

▶ [PREVIEW SCREEN \(page 10\)](#)

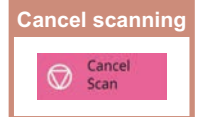





## Scan to USB memory device

1

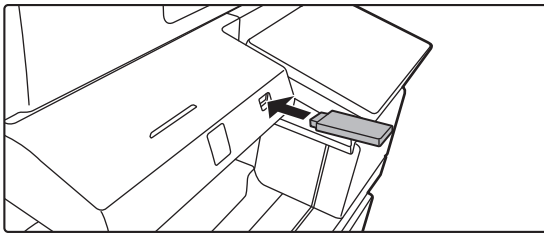

**Connect the USB memory device to the machine.**

- Use FAT32, NTFS or exFAT format for USB memory device.
- When the format of the USB memory device is FAT32, use a 32 GB or less USB memory device.

2

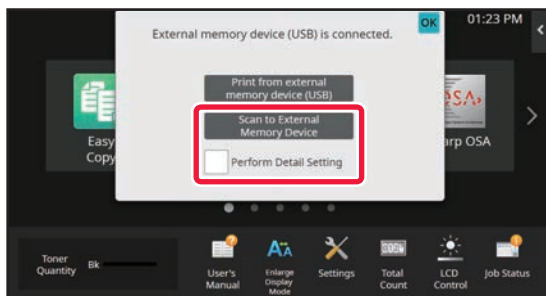

**When a screen for selecting the action appears, tap [Scan to External Memory Device].**

- To select detailed settings in normal mode, select the [Perform Detail Setting] checkbox .
- ▶ [Easy Mode and Normal Mode \(page 8\)](#)
- If the machine/device save screen is open, this screen will not appear.

3

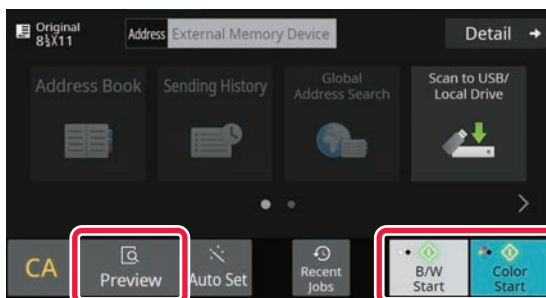

**Tap the [Color Start] key or [B/W Start] key.**

To check a preview of a document, tap the [Preview] key.

- ▶ [PREVIEW SCREEN \(page 10\)](#)

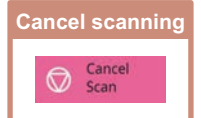

4

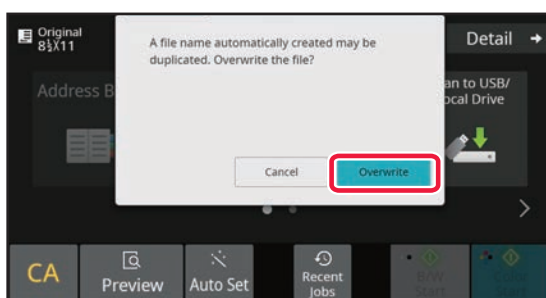

**After scanning all originals, tap the [Overwrite] key.**

5

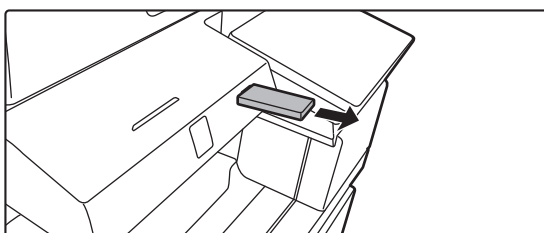

**Check the [Sending data has been completed.] message, and remove the USB memory device from the machine.**





# PRINTING A SAVED FILE

You can retrieve a file stored by document filing and print or transmit the file. You can also print files saved in a USB memory device or a shared folder. The steps for printing the "Copy\_20201010\_112030" file saved in the main folder are explained below.

1



Tap the [Home Screen] key.  
Home screen appears.

2

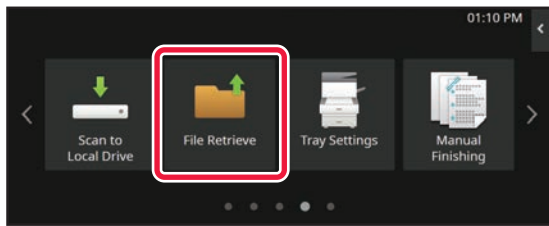

Tap the [File retrieve] mode icon.

3

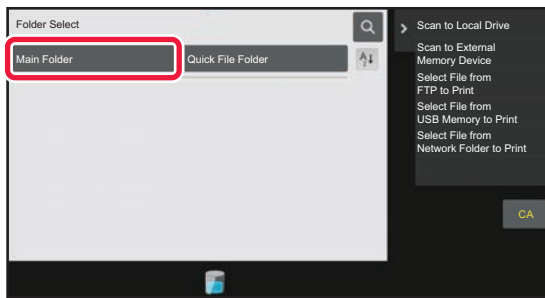

Select the file and print.

(1) Tap the [Main Folder] key.

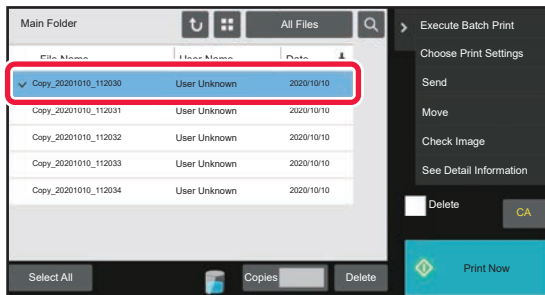

(2) Tap the key of the file that you wish to print.

In this case, tap the "Copy\_20201010\_112030" key. To check a preview of the printed image, tap [Check Image] on the action panel.

If you want to delete the file after printing, tap [Print and Delete the Data] on the action panel so that  appears.

(3) Tap the [Print Now] key.



# SETTING MODE

The setting mode let you adjust the operation of the machine to suit the needs of your workplace. This section briefly introduces several of the setting mode.

For detailed explanations of the system settings, see "SETTING MODE" in the User's Manual.

## SETTING MODE

The date and time can be set, fax and scan destinations can be stored, document filing folders can be created, and various other settings related to the operation of the machine can be configured in the setting mode screen.

The procedure for opening the setting mode screen and the items in the screen are explained below.

## DISPLAYING THE SETTING MODE ON THE MACHINE

1



Tap the [Home Screen] key.

Home screen appears.

2

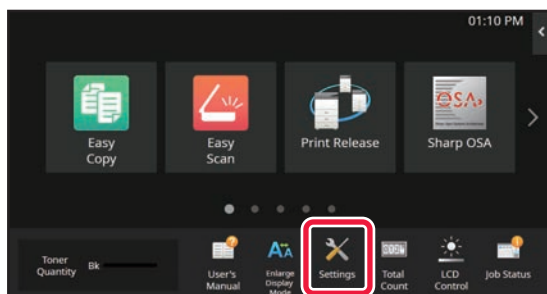

Tap the [Settings] key.

The setting mode screen appears.

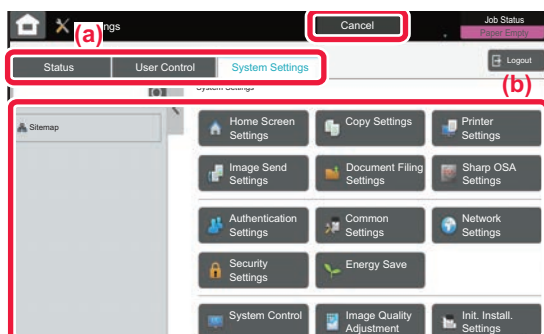

Tap the item that you want to set on menu tab (a) or setting menu (b).

To exit setting mode, tap the [Cancel] key.

▶ [SETTING MODE WHEN AN ADMINISTRATOR IS LOGGED IN \(page 44\)](#)



## SETTING MODE WHEN AN ADMINISTRATOR IS LOGGED IN

An administrator can configure settings that are more advanced than the settings available to a guest or user. When user authentication is enabled, settings may be allowed without entering the administrator password based on the rights of the logged in user. For the state of the settings, ask the administrator of the machine.

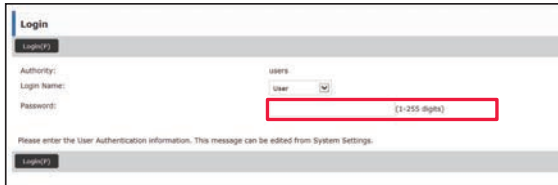

When you select an item in setting mode that requires administrator login, the administrator login screen will appear.

For the items available in setting mode when an administrator is logged in, see "SETTING MODE" in the User's Manual.

## DISPLAYING THE SETTING MODE ON THE WEB PAGE

For information on how to display web pages, see "[ACCESSING THE WEB SERVER IN THE MACHINE \(page 22\)](#)"

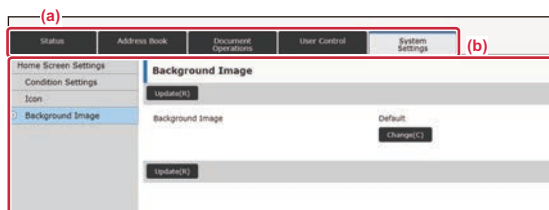

From the Menu tab (a) and the Settings menu (b), click the item you want to set.

To exit the setting mode, close your web browser.



## WHAT YOU CAN DO IN THE SETTING MODE

The following settings can be configured in setting mode.

Some settings may not appear on the touch panel of the machine, or in the Web browser on your computer. Some settings may not appear due to the specifications of your machine and the peripheral devices that are installed.

Menu	Overview	
Status	Displays paper tray information and device information.	
Address Book	Use to edit the address book.	
Document Operations	Use to perform actions on a file using the Document Filing function.	
User Control	This is used to store, edit, and delete users when user authentication is enabled.	
System Settings	Configure the main settings for the machine such as date settings and paper tray settings. You can configure the following settings.	
	Home Screen Settings	You can select settings for the machine's home screen, such as changing the home screen background.
	Copy Settings	You can select copy settings.
	Printer Settings	You can select print settings.
	Image Send Settings	Configure settings for image send, such as fax and Scan to E-mail.
	Document Filing Settings	You can select Document Filing settings.
	Sharp OSA Settings	You can select Sharp OSA settings.
	Authentication Settings	Configure the user authentication method. Alternatively, configure the IC card.
	Common Settings	You can configure machine settings such as date settings and tray settings.
	Network Settings	You can configure network settings such as Interface Settings and NAS settings.
	Security Settings	You can configure machine security settings such as authentication and changing the administrator password.
	Energy Save	The machine's power consumption can be reduced by Eco Mode setting.
	System Control	You can configure machine backup and job log settings.
Image Quality Adjustment	You can perform image adjustment on the machine.	
Initial Installation Settings	This is a group of settings that are required when you initially install the machine.	



## **Please note**

- For information on your operating system, please refer to your operating system manual or the online Help function.
- The explanations of screens and procedures in a Windows environment are primarily for Windows 10<sup>®</sup>. The screens may vary depending on the version of the operating system or the software application.
- The explanations of screens and procedures in a macOS environment are based on macOS 11 in the case of macOS. The screens may vary depending on the version of the operating system or the software application.
- Wherever "BP-xxxx" appears in this manual, please substitute your model name for "xxxx".
- Considerable care has been taken in preparing this manual. If you have any comments or concerns about the manual, please contact your dealer or nearest SHARP Service Department.
- This product has undergone strict quality control and inspection procedures. In the unlikely event that a defect or other problem is discovered, please contact your dealer or nearest SHARP Service Department.
- Aside from instances provided for by law, SHARP is not responsible for failures occurring during the use of the product or its options, or failures due to incorrect operation of the product and its options, or other failures, or for any damage that occurs due to use of the product.

## **Warning**

- Reproduction, adaptation or translation of the contents of the manual without prior written permission is prohibited, except as allowed under copyright laws.
- All information in this manual is subject to change without notice.

## **Illustrations and the operation panel and touch panel shown in this manual**

The peripheral devices are generally optional, however, some models include certain peripheral devices as standard equipment. The explanations in this manual assume the BP-70M90.

For some functions and procedures, the explanations assume that devices other than the above are installed.

<p>The display screens, messages, and key names shown in the manual may differ from those on the actual machine due to product improvements and modifications.</p>
--

# **SHARP**

SHARP CORPORATION