

## Quick Start Guide



### BEFORE USING THE MACHINE



Functions of the machine and procedures for placing originals and loading paper

### COPIER



Using the copy function

### PRINTER



Using the printer function

### SCANNER



Using the scan function

### DOCUMENT FILING



Storing jobs as files on the local drive

### SETTING MODE



Configuring settings to make the machine easier to use

# HOW TO USE MANUALS

## Start Guide

This manual explains basic procedures for using the machine, cautions for safe use of the machine, and information for the administrator. Read this manual before using the machine.

For detailed operating procedures and troubleshooting information, see the user's manual.

## User's Manual

Detailed explanations of the functions that can be used on the machine are provided in the "User's Manual".

The manuals for this machine are uploaded to a website. Tap [User's Manual] on the touch panel of the machine and a QR code will be displayed.

Scan the QR code with a smartphone or other device to go to the website where manuals are available.

You can download various manuals from the website. The user's manual is also uploaded in HTML format and can be viewed on your smartphone or computer.

## Software Setup Guide

This guide explains how to install the software and configure settings to use the machine as a printer or scanner.

## Cloud Connect Guide

This guide explains how to connect the machine to a cloud service on the Internet, enabling you to upload scanned data and print data stored in the cloud.

## Downloading the User's Manual in PDF format

Access the website from the following URL or QR code.

The website is displayed in English.

Switch to your preferred language before viewing and downloading the manual.

In addition, the same "User's Manual", you can see download to your computer from the Web site.

\* Manual types may be updated. For more information, see our website.

URL:

<https://global.sharp/restricted/products/copier/downloads/manuals/select.html>



# TABLE OF CONTENTS

HOW TO USE MANUALS .....	2
--------------------------	---

## BEFORE USING THE MACHINE

PART NAMES AND FUNCTIONS .....	5
TURNING ON/OFF THE POWER .....	8
OPERATION PANEL .....	9
PLACING ORIGINALS .....	12
LOADING PAPER .....	13
SAVING CONTACTS IN THE ADDRESS BOOK .....	25
ACCESSING THE WEB SERVER IN THE MACHINE .....	26
USER AUTHENTICATION .....	27
INSTALLING THE PRINTER DRIVER .....	28

## COPIER

MAKING COPIES .....	30
COPYING ON SPECIAL PAPER (Bypass Copy) .....	32

## PRINTER

PRINTING IN A WINDOWS ENVIRONMENT .....	34
PRINTING IN A macOS ENVIRONMENT .....	36

## SCANNER

NETWORK SCANNER FUNCTION.....	38
SCANNING AN ORIGINAL .....	39

## DOCUMENT FILING

SAVING A DOCUMENT ONLY (Scan to Local Drive).....	41
PRINTING A SAVED FILE.....	43

## SETTING MODE

SETTING MODE .....	44
--------------------	----



# BEFORE USING THE MACHINE

This section provides general information about the machine, including the names and functions of the parts of the machine and its peripheral devices, and the procedures for placing originals and loading paper.

## PART NAMES AND FUNCTIONS

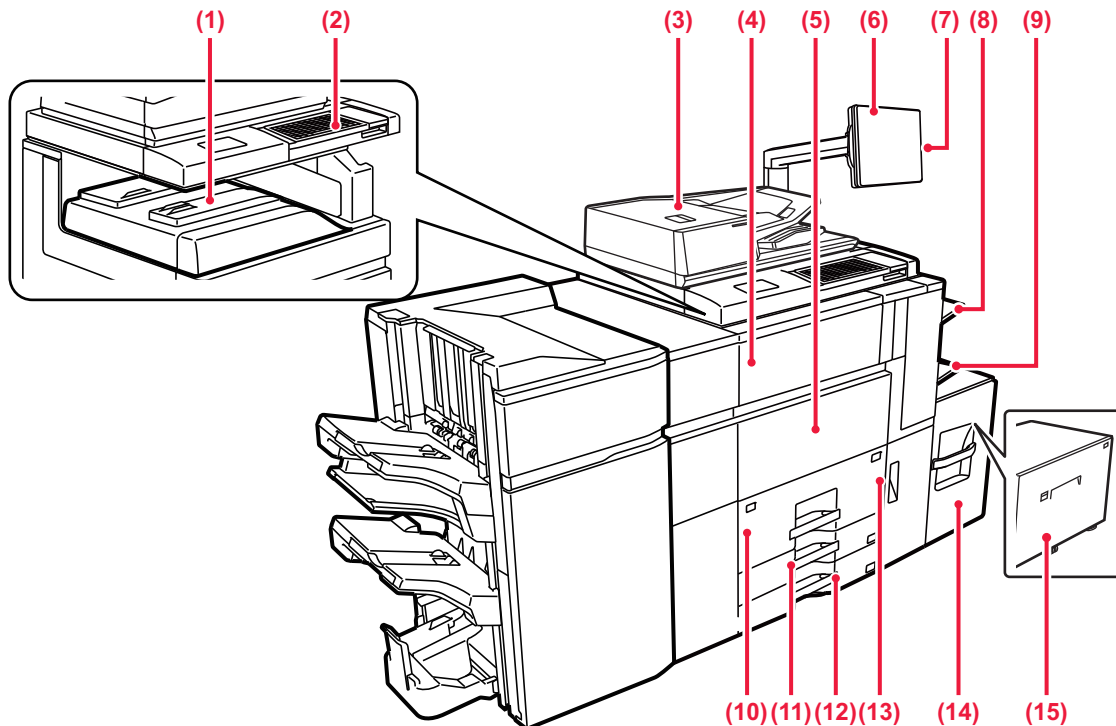

- (1) **Output tray (centre tray)\***  
Printed paper is output into this tray.
- (2) **Keyboard**  
Use this as a substitute for the soft keyboard displayed on the touch panel.
- (3) **Automatic document feeder**  
This automatically feeds and scans multiple originals. Both sides of 2-sided originals can be automatically scanned at one time.  
▶ [USING THE AUTOMATIC DOCUMENT FEEDER \(page 12\)](#)
- (4) **Toner cover (Upper front cover)**  
Open this cover to replace the toner cartridge or to remove misfed paper in the paper pass unit.
- (5) **Front cover**  
Open this cover to switch the main power switch to "On" or "Off".  
▶ [TURNING ON/OFF THE POWER \(page 8\)](#)
- (6) **Operation panel**  
This panel hosts the [Power] button, main power indicator, and touch panel. Use the touch panel to operate each of these functions.  
▶ [OPERATION PANEL \(page 9\)](#)
- (7) **USB connector (A type)**  
This is used to connect a USB device such as a USB memory device to the machine.  
For the USB cable, use a shielded cable.  
Supports USB 2.0 (Hi-Speed).
- (8) **Right tray\***  
As required, paper can be output into the right tray.
- (9) **Bypass tray**  
Use this tray to feed paper manually.  
When loading paper larger than A4R or 8-1/2" × 11"R, pull out the extension guide.  
▶ [LOADING PAPER IN OTHER TRAYS \(page 17\)](#)
- (10) **Tray 1**  
Store paper in this tray. Up to 1200 sheets can be stored.  
▶ [LOAD PAPER INTO THE TRAY 1 - 4 \(page 14\)](#)
- (11) **Tray 3**  
Store paper in this tray. Up to 500 sheets can be stored.  
▶ [LOAD PAPER INTO THE TRAY 1 - 4 \(page 14\)](#)
- (12) **Tray 4**  
Store paper in this tray. Up to 500 sheets can be stored.  
▶ [LOAD PAPER INTO THE TRAY 1 - 4 \(page 14\)](#)
- (13) **Tray 2**  
Store paper in this tray. Up to 800 sheets can be stored.  
▶ [LOAD PAPER INTO THE TRAY 1 - 4 \(page 14\)](#)
- (14) **Tray 5 (MX-LC12)\***  
Store paper in this tray. Up to 3500 sheets can be stored.  
▶ [LOADING PAPER IN OTHER TRAYS \(page 17\)](#)
- (15) **Tray 5 (MX-LCX3 N)\***  
Store paper in this tray. Up to 3000 sheets can be stored.  
▶ [LOADING PAPER IN OTHER TRAYS \(page 17\)](#)

\* Peripheral device. For more information, see the User's Manual. Equipped standard or not available in some countries and regions. Not available on some models. Contact your dealer or nearest authorised service representative.



## BEFORE USING THE MACHINE

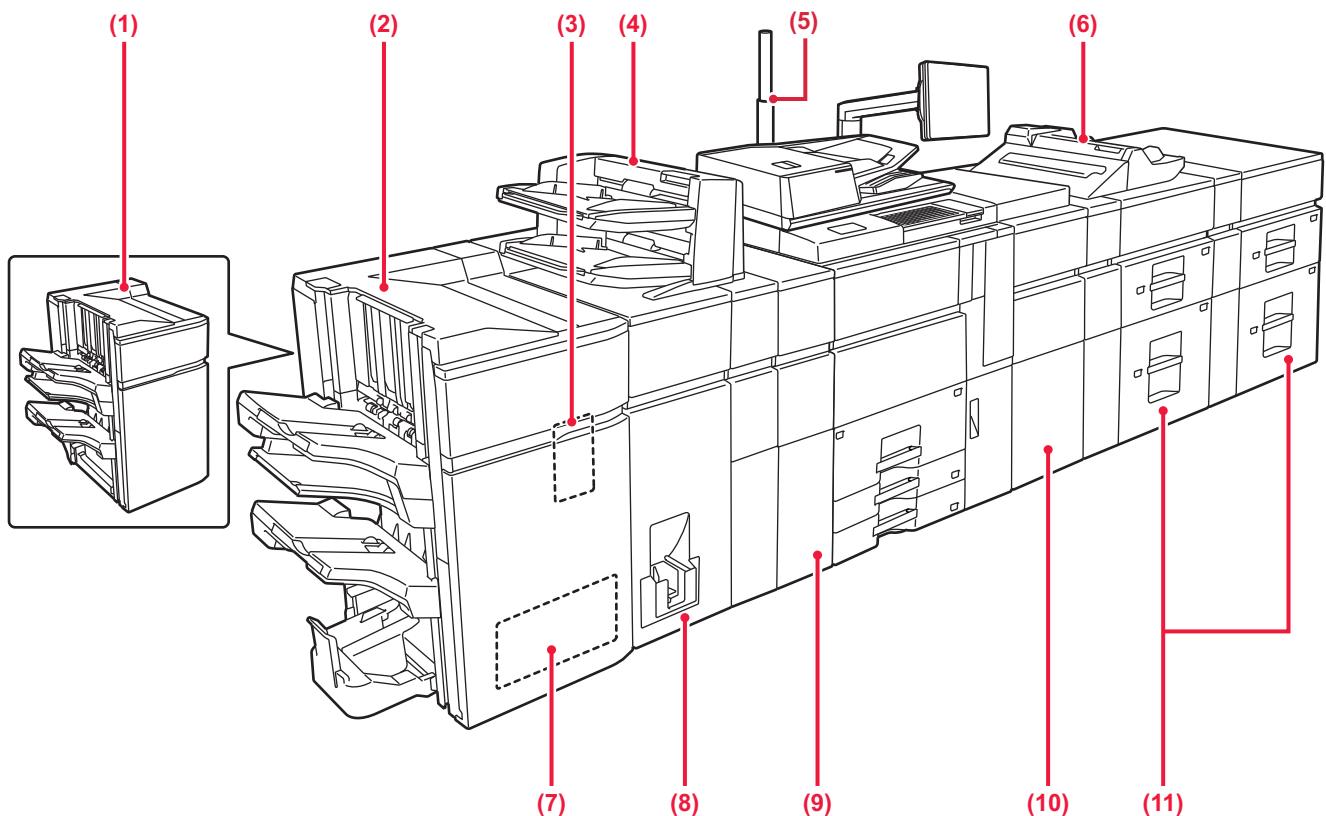

- (1) **Finisher (large stacker)\***  
This staples and outputs paper.
- (2) **Saddle stitch finisher (large stacker)\***  
This staples and folds paper.
- (3) **Punch module (MX-PN13A/B/C/D)\***  
This punches and outputs paper.
- (4) **Inserter\***  
Covers and insertion sheets to be inserted into printed sheets can be loaded.  
Using the manual finishing function, you can directly feed paper into the finisher or saddle stitch finisher to staple, punch or fold the paper.
- (5) **Status indicator\***  
The status of the machine is indicated.
- (6) **Bypass tray\***  
Use this tray to feed paper manually.  
When loading paper larger than A4R or 8-1/2" × 11"R, pull out the extension guide.  
▶ [LOADING PAPER IN OTHER TRAYS \(page 17\)](#)
- (7) **Trimming module\***  
This trims the excess of saddle-stitched output.
- (8) **Folding unit\***  
This folds and outputs paper.
- (9) **Curl correction unit\***  
This punches and outputs paper.
- (10) **Paper pass unit\***  
This feeds paper to the machine.
- (11) **Large capacity trays\***  
Store paper in this tray. Up to 2500 sheets can be stored in each tray.  
▶ [LOADING PAPER IN OTHER TRAYS \(page 17\)](#)

\* Peripheral device. For more information, see the User's Manual.  
Equipped standard or not available in some countries and regions. Not available on some models. Contact your dealer or nearest authorised service representative.

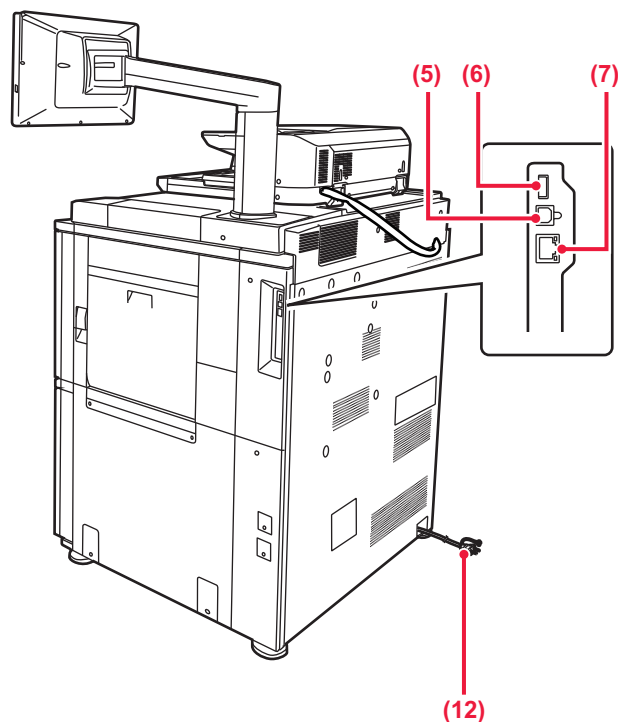
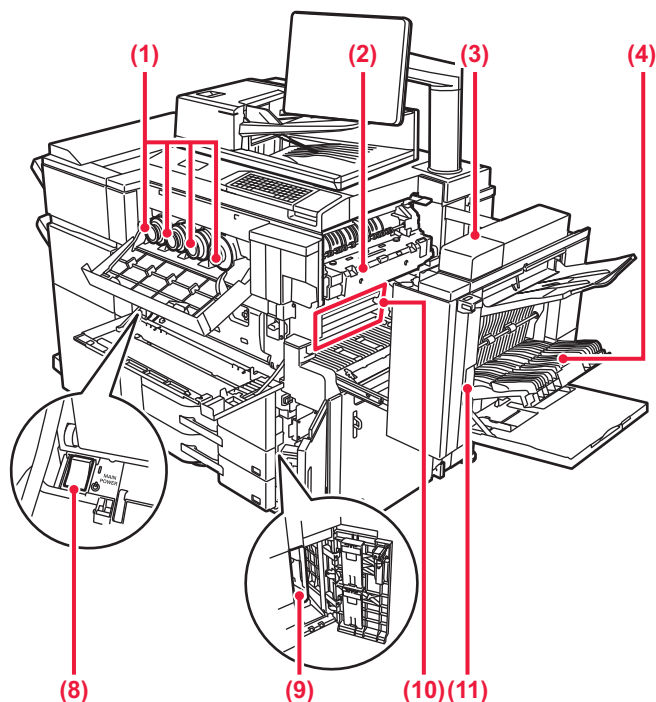

- (1) **Toner cartridge**  
This cartridge contains toner. When the toner in a cartridge runs out, the cartridge of the colour that ran out must be replaced.
- (2) **Fusing unit**  
Heat is applied here to fuse the transferred image onto the paper.

 The fusing unit is hot. Take care not to burn yourself when removing a misfeed.

- (3) **Right side cover**  
Open this cover to remove a misfeed.
- (4) **Paper reversing section cover**  
This unit is used for reversing paper when 2-sided printing is performed. Open this cover to remove a paper misfeed.
- (5) **USB connector (B type)**  
Cannot be used.
- (6) **USB connector (A type)**  
This is used to connect a USB device such as a USB memory device to the machine. Supports USB 2.0 (Hi-Speed) and USB3.0 (SuperSpeed).
- (7) **LAN connector**  
Connect the LAN cable to this connector when the machine is used on a network. Use a shielded LAN cable.

- (8) **Main power switch**  
Use this switch to turn on the power for the machine.  
▶ [TURNING ON/OFF THE POWER \(page 8\)](#)
- (9) **Toner collection container**  
This container collects excess toner that remains after printing.

 A service technician collects replaced toner collection container.

- (10) **Transfer belt**  
This belt takes the image formed with toner off the photoconductive unit and transfers the image onto paper.

 Do not touch or damage the transfer belt. This may cause a defective image.

- (11) **Right side cover release lever**  
To remove a paper misfeed, pull and hold this lever up to open the right side cover.
- (12) **Power plug**



# TURNING ON/OFF THE POWER

This section describes how to turn on/off the machine's power and how to restart the machine.

Operate two power switches: the main power switch inside the front cover, located in the lower left corner, and the [Power] button on the operation panel.

## Turning on the power

- Turn the main power switch to the " | " position.
- When the main power indicator lights, press the [Power] button.

## Turning off the power

- Press the [Power] button to turn off the power, and then tap the [Power Off] key.  
To turn off the power for an extended time, press the [Power] button to turn off the power, and switch the main power switch to the "⏻" position after the operation panel screen disappears.

## Restart the machine

- Press the [Power] button to turn off the power, and tap the [Power off] key on the touch panel. After that, press the [Power] button again to turn on the power.

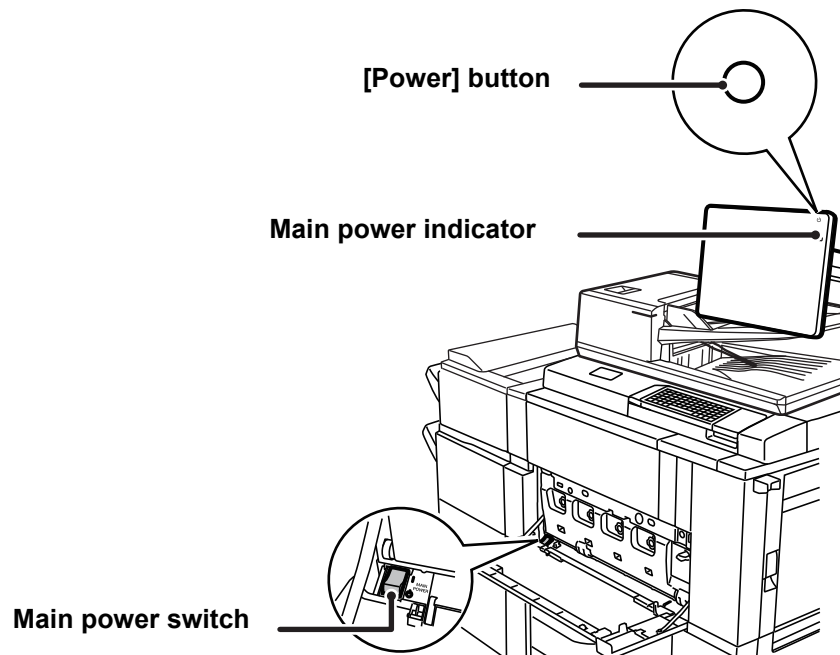

- When turning off the main power switch, press the [Power] button on the operation panel and then turn the main power switch to the "⏻" position.  
In a sudden case of main power outage, turn the power for the machine back on and then turn it off in the correct order. If the machine is left for a long time with the main power having been turned off prior to the [Power] button being turned off, abnormal noises, degraded image quality or other problems may result.
- Turn off both the [Power] button and the main power switch and unplug the power cord if you suspect a machine failure, if there is a bad thunderstorm nearby, or when you are moving the machine.



In order for some settings to take effect, the machine must be restarted. In some states of the machine, restarting with the [Power] button may not make the settings take effect. In this case, turn off the main power switch and then turn it on again.





# OPERATION PANEL

Pressing the [Home Screen] key on the operation panel displays the home screen on the touch panel. The home screen displays the keys for selecting modes or functions.

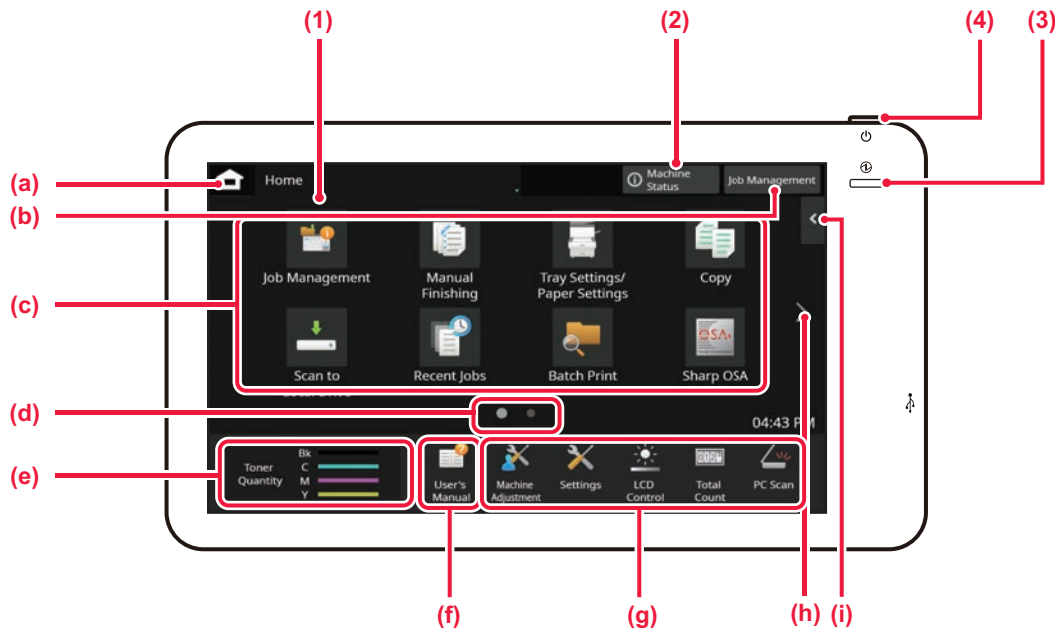

## (1) Touch Panel

Messages and keys appear on the touch panel display. Operate the machine by directly tapping the displayed keys.

- (a) Display the home screen
- (b) Display the job in progress or waiting with text or icon.
- (c) Select shortcut keys for modes or functions.
- (d) Switch the pages for displaying shortcut keys.
- (e) Display Toner Quantity.
- (f) Display a QR code indicating the web site of the User's Manual.
- (g) Use these keys to select functions that make the machine easier to use.
- (h) Switch the pages for displaying shortcut keys.

- (i) Select functions that can be utilized in respective modes. Tap the tab, and the list of function keys is displayed.

## (2) [Machine Status] key

Displays information such as the status of the machine, details of errors, and the remaining paper level in the paper feed tray.

## (3) Main power indicator

This lamp lights up when the machine's main power switch is in the "I" position. While the light is blinking, the power cannot be turned on by pressing the [Power] button.

## (4) [Power] button

Use this button to turn the machine's power on and off.

## Easy Mode and Normal Mode

In the copy and image send modes, there are two types of operation screens: easy mode and normal mode.

The easy mode consists of the minimum necessary functions, such as frequently used functions, and most operations can be performed smoothly.

When you want to use detailed settings or special functions, use the normal mode.

In normal mode, all functions are available.

(Example: easy mode and normal mode in copy mode)

### Easy Mode

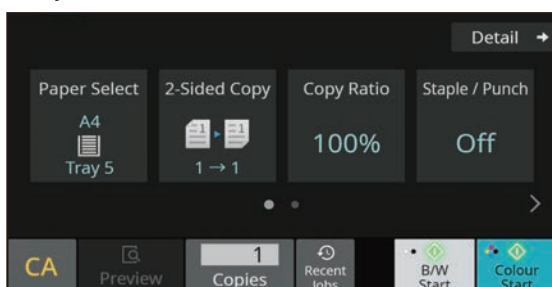

### Normal Mode

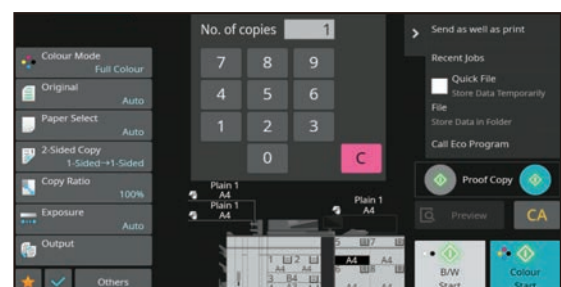



## TO CHANGE THE ANGLE OF THE OPERATION PANEL

You can change the angle of the operation panel.  
Adjust the angle for ease of viewing.

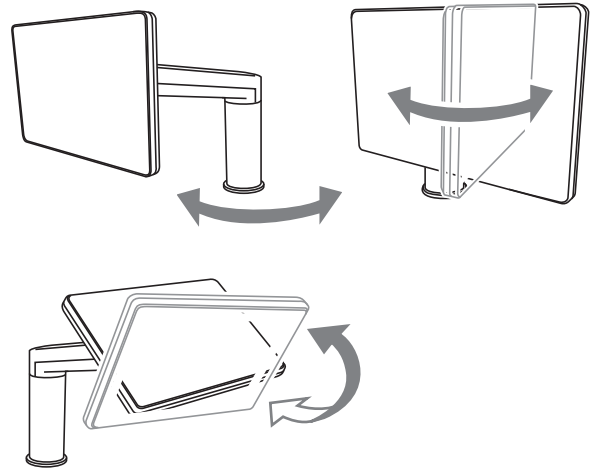



## CHECKING THE STATUS OF A JOB / PRIORITY / CANCELLING

To display the Job Status screen, tap the [Job Management] key in the home screen, or tap the [Job Management] key that appears in the upper right corner of each mode screen.

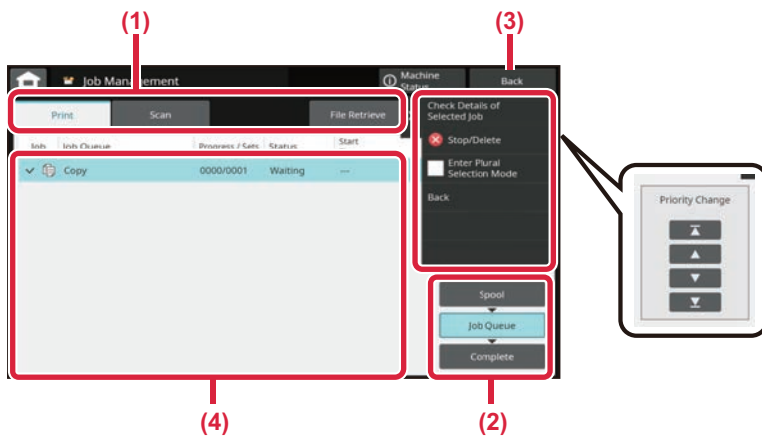

### Check the job management

- (1) Tap the tab of the mode you want to check. Check copy jobs and print jobs on the [Print] tab.
- (2) Tap the [Job Queue] or [Complete] key.
- (3) Tap the [Back] key to return to the original screen.
- (4) Check the jobs in the list. If you want to give a job priority or cancel a job, tap that job.

### To give the job priority

Tap [Change Job Priority], and tap a Change Priority key.

### To cancel the job

If you want to cancel a job, tap that job and tap [Stop/Delete].

## PREVIEW SCREEN

You can tap the [Preview] key to open the Preview screen. In the Preview screen on the touch panel, you can view previews of jobs and images stored in the machine.

### Easy mode

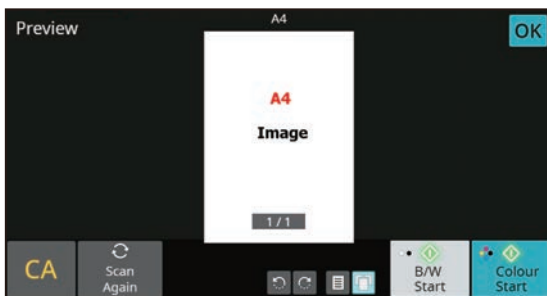

### Normal mode

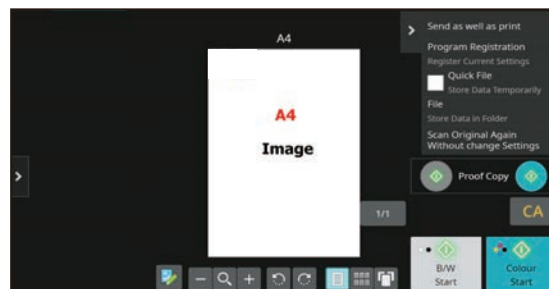



# PLACING ORIGINALS

The automatic document feeder can be used to automatically scan many originals at once, and this saves you the trouble of manually feeding each original.

For originals that cannot be scanned using the automatic document feeder, such as a book or a document with notes attached, use the document glass.

## USING THE AUTOMATIC DOCUMENT FEEDER

When using the automatic document feeder, place the originals in the document feeder tray.

Make sure an original has not been placed on the document glass.

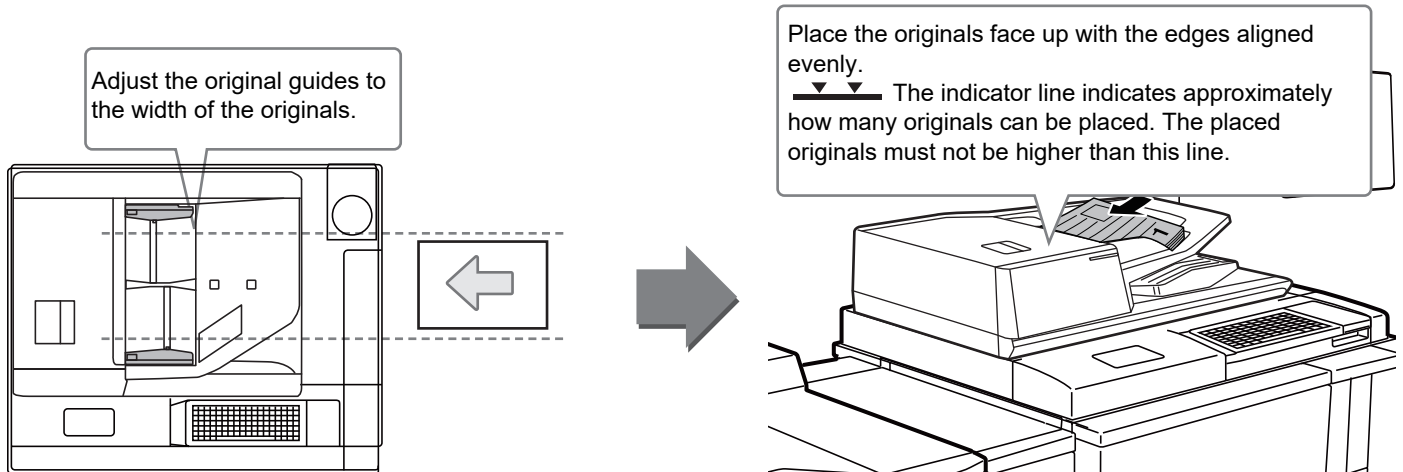

## Loading a Business Card

When scanning a business card with the automatic document feeder, align the original guide to the size of the card.

## USING THE DOCUMENT GLASS

Take care that your fingers are not pinched when closing the automatic document feeder.

After placing the original, be sure to close the automatic document feeder. If left open, parts outside of the original will be copied black, causing excessive use of toner.

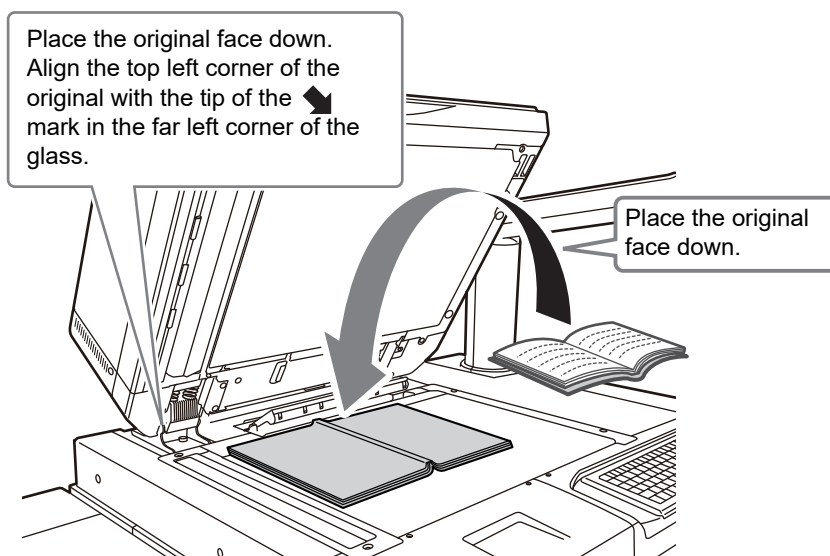

Set the orientation of the image to ensure that the orientation of the placed original is correctly recognized. For details, see the User's Manual.



# LOADING PAPER

## NAMES AND LOCATIONS OF TRAYS

When a large capacity tray is installed

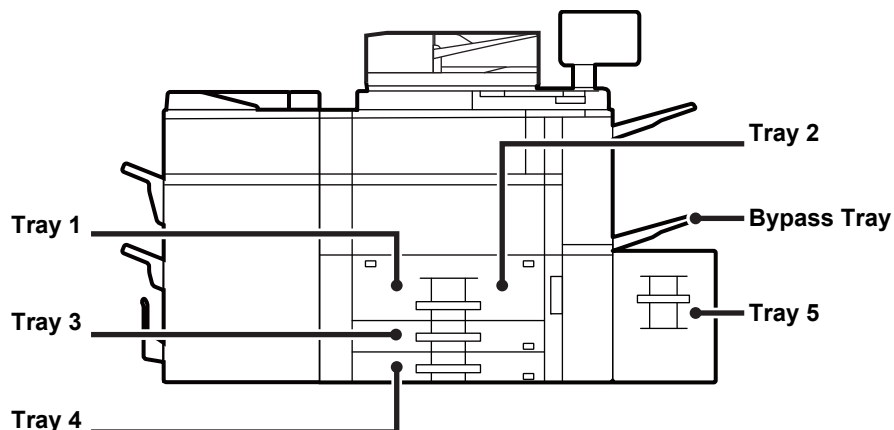

When two large capacity trays are installed

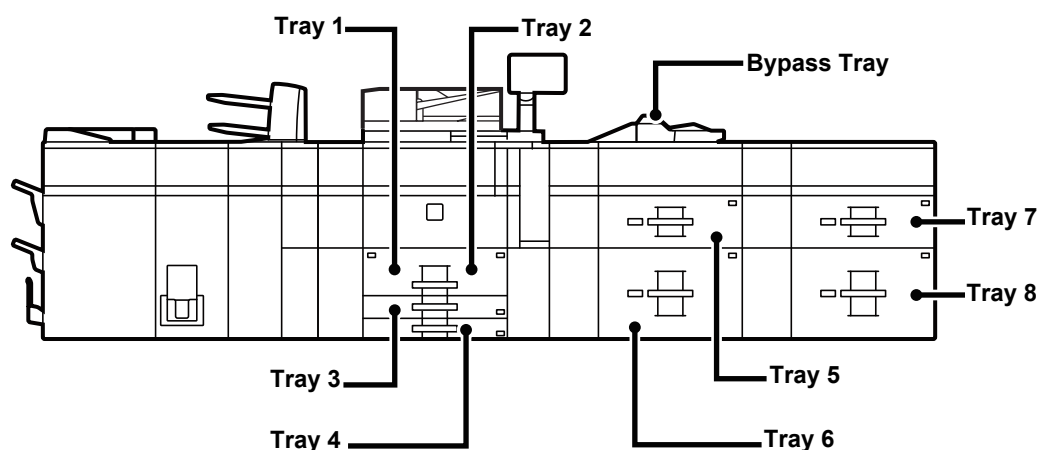

### Setting orientation of the print side

The setting orientation varies for the print side of paper, depending on the tray used. For "Letter Head" and "Pre-Printed", set the paper in the reverse orientation.

Place with the print side facing the direction indicated below.

Tray	In normal status	With letter head or pre-printed paper set
Trays 1 - 4	Facing up	Facing down
Bypass tray, Tray 5, Tray 6, Tray 7, Tray 8	Facing down	Facing up



# LOAD PAPER INTO THE TRAY 1 - 4

## Tray 1 - 2

1

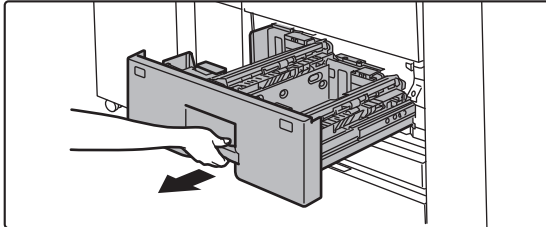

### Pull out the paper tray.

Gently pull the tray out until it stops.



Keep holding the handle until the lock is released.

2

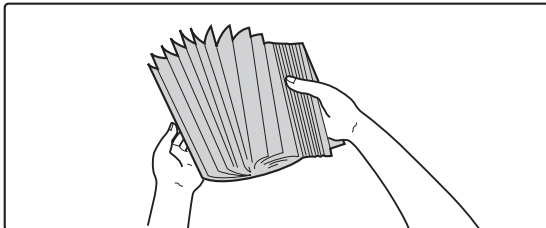

### Fan the paper.

Fan the paper well before loading it. If the paper is not fanned, multiple sheets may feed at once and cause a misfeed.

3

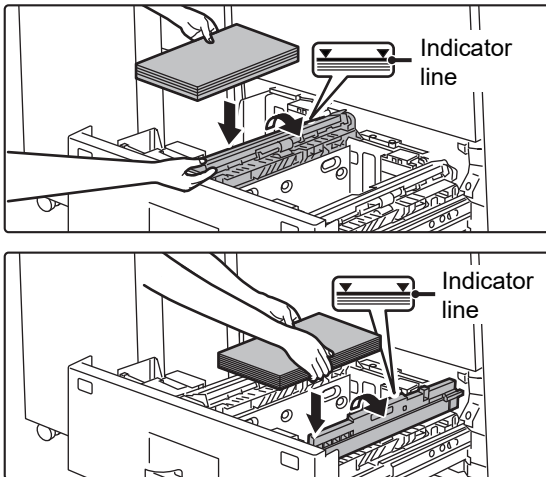

### Lift the feed roller, and place paper into the tray.

Load the paper with the print side facing up. The stack must not be higher than the indicator line (maximum of 1200 sheets for tray 1, or maximum of 800 sheets for tray 2).

4

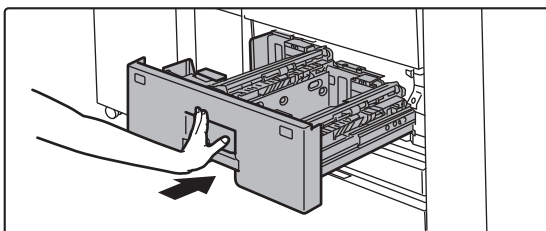

### Lower the feed roller, and gently push the paper tray into the machine.

Push the tray firmly all the way into the machine slowly. Forcefully inserting the paper may cause skewed feeding and paper misfeeds.



## Tray 3 - 4

1

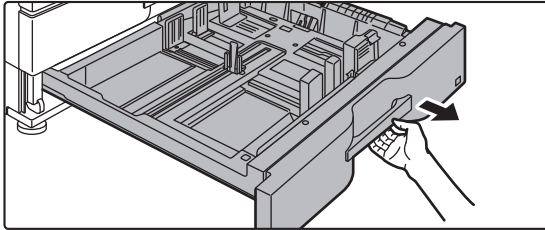

### Pull out the paper tray.

Gently pull the tray out until it stops.

To load paper, go to step 3.

To load a different size of paper, go to the next step.



Keep holding the handle until the lock is released.

2

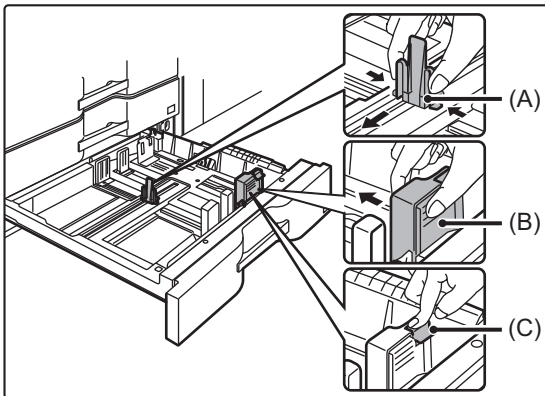

### Adjust guide plates A and B by squeezing their lock levers and sliding them to match the longitudinal and transversal dimensions of the paper to be loaded.

(1) Squeeze the lock knob on guide plate A and slide to the desired paper size.

(2) Squeeze the lock knob on guide plate B and slide to the desired paper size.

If slid to a standard paper size, guide plate B will lock automatically.

(3) For a non-standard paper size, after sliding guide plate B to the desired size, press the lock button (C).



A non-standard size of paper can only be loaded in tray 4. A non-standard size of paper cannot be loaded in tray 3.

3

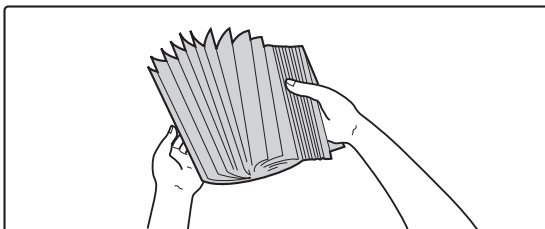

### Fan the paper.

Fan the paper well before loading it. If the paper is not fanned, multiple sheets may feed at once and cause a misfeed.



4

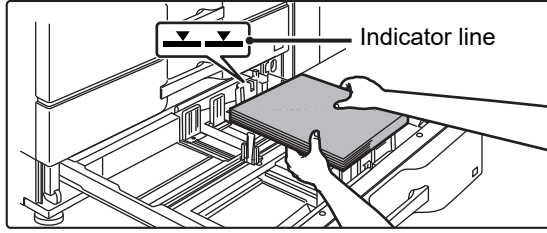

## Insert the paper into the tray.

Load the paper with the print side facing up. The stack must not be higher than the indicator line (maximum of 500 sheets).

5

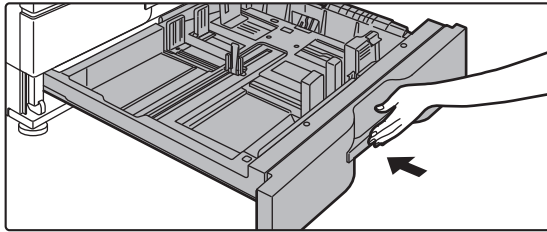

## Gently push the paper tray into the machine.

Push the tray firmly all the way into the machine slowly. Forcefully inserting the paper may cause skewed feeding and paper misfeeds.

### Loading envelope in tray 4

Load the paper with the copy and print side facing up. The diagram shows an example of printing on the front side. The maximum number of sheets 50 may not exceed the indicator line.

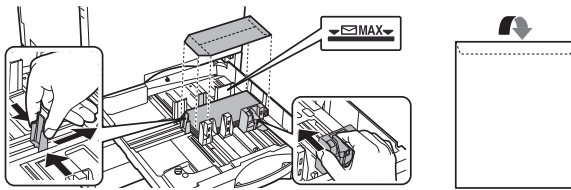

When loading envelopes in the tray 4, set the paper type.

▶ [CHANGE THE SETTING OF THE PAPER TRAY \(page 24\)](#)





# LOADING PAPER IN OTHER TRAYS

## Bypass tray (on the machine)

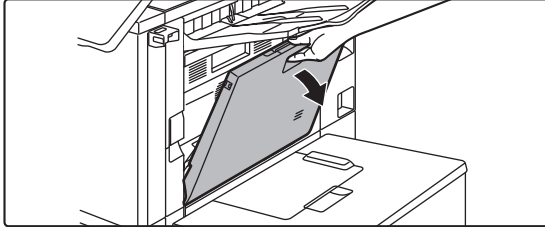
**1**

Open the bypass tray.



When loading paper larger than A4R or 8-1/2" × 11"R, pull out the extension guide. Pull the bypass tray extension all the way out.

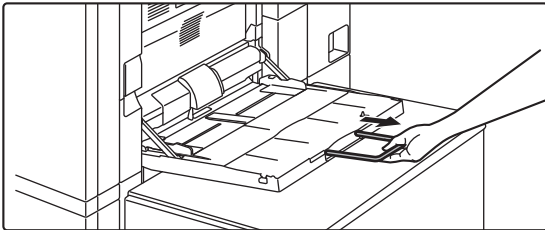

Do not place heavy objects on the bypass tray or press down on the tray.

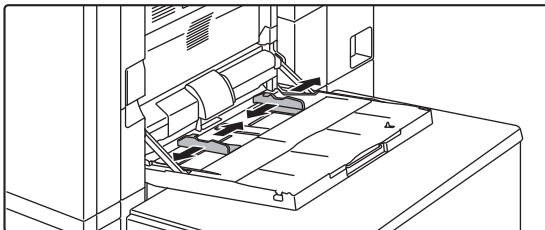
**2**

Adjust the bypass tray guides to the size of paper to be loaded.

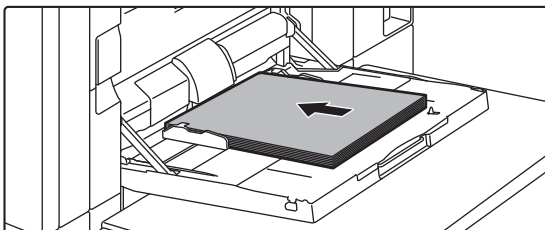
**3**

Insert the paper along the bypass tray guides all the way into the bypass tray until it stops.

Load paper with the print side facing down.



- Do not force the paper in.
- If the bypass tray guides are set wider than the paper, move the bypass tray guides in until they correctly fit the width of the paper. If the bypass guides are set too wide, the paper may skew or be creased.





## Bypass tray (on the large capacity trays)

1

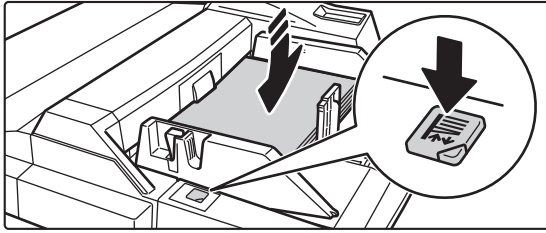

**To replace the paper in the bypass tray, press the operation button and remove the paper.**

The paper table goes down. The operation button blinks while the paper table goes down. The button lights up when the paper table has gone down. Do not remove the paper until the button ceases blinking.

2

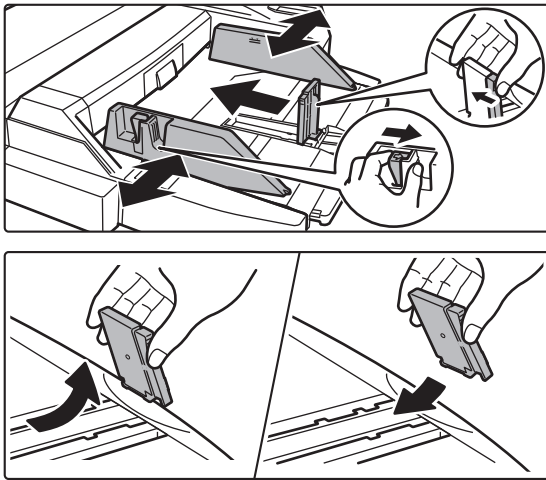

**Adjust the bypass tray guides to the size of paper to be loaded.**

Grasp the guide lock lever to adjust the bypass tray guides to the paper size. Be sure to adjust the bypass tray guides at the rear end.

When loading paper larger than A4R or 8-1/2" x 11"R, be sure to pull out the bypass tray extension. Remove the bypass tray guide at the rear end and attach them to the inserter tray.



- Pull the bypass tray extension all the way out.
- When loading paper larger than A3W or 8-1/2" x 14", remove the bypass tray guides at the rear end.



Do not place heavy objects on the bypass tray or press down on the tray.

3

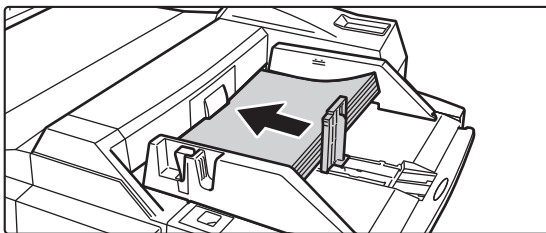

**Insert the paper along the bypass tray guides all the way into the bypass tray until it stops and adjust the right-side guide.**

Load paper with the print side facing down.

The stack must not be higher than the indicator line.

A maximum of 500 sheets of paper can be loaded into the tray.



- Do not force the paper in.
- If the bypass tray guides are set wider than the paper, move the bypass tray guides in until they correctly fit the width of the paper. If the bypass guides are set too wide, the paper may skew or be creased.

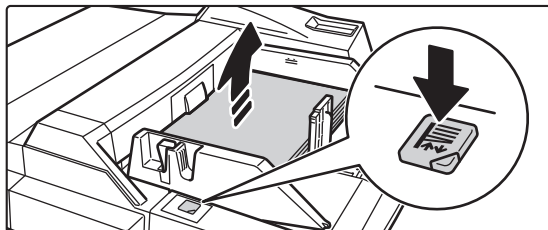

4

**Press the operation button.**

The paper table goes up. The operation button blinks while the paper table goes up. The button lights up when the paper table has gone up.

**Loading envelopes**

Only the front side of envelopes can be printed or copied on. Place the front side facing down.

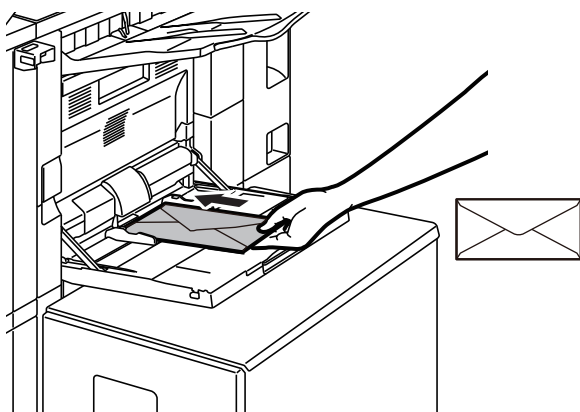

When loading envelopes in the bypass tray, set the paper type.

▶ [CHANGE THE SETTING OF THE PAPER TRAY \(page 24\)](#)



## Large capacity tray (MX-LC12)

1

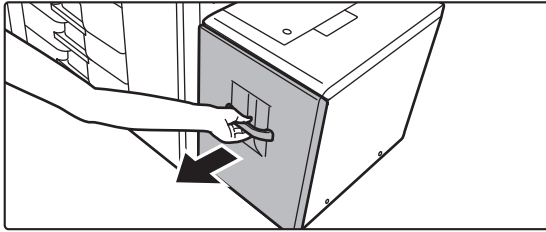

### **Pull out the paper tray.**

Gently pull the tray out until it stops.

2

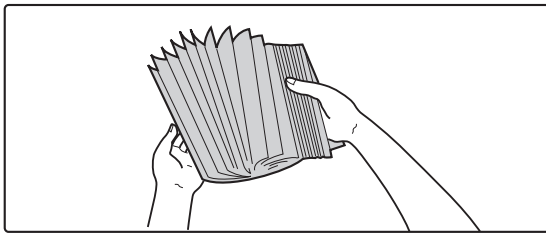

### **Fan the paper.**

Fan the paper well before loading it. If the paper is not fanned, multiple sheets may feed at once and cause a misfeed.

3

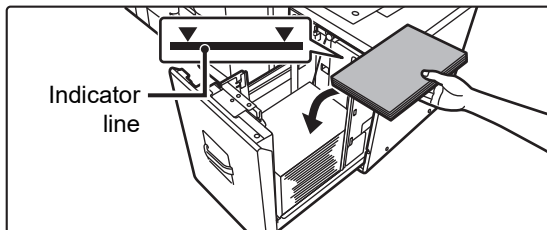

### **Place the paper in the centre of the paper table.**

Load the paper with the print side facing down. The stack must not be higher than the indicator line (maximum of 3500 sheets).

4

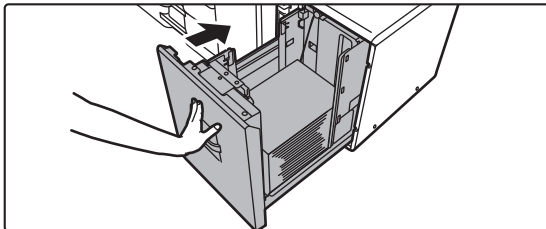

### **Gently push the paper tray into the machine.**

Push the tray firmly all the way into the machine slowly. Forcefully inserting the paper may cause skewed feeding and paper misfeeds.



## Large capacity tray (MX-LCX3 N)

1

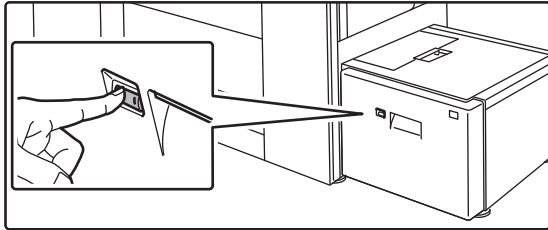

### Press the operation button.

The operation button blinks, and the tray paper table goes down to the paper loading position. Wait until the operation button light goes off.



Do not pull out the tray until the light goes off. If you pull out the tray forcibly while the button lights up or blinks, a machine failure may be resulted.

2

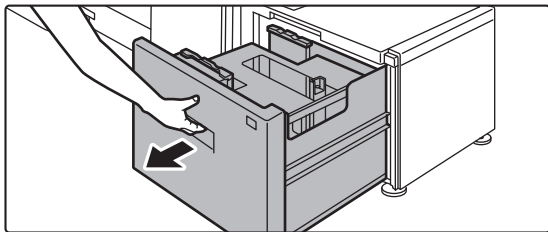

### Pull out the paper tray.

Gently pull the tray out until it stops.

3

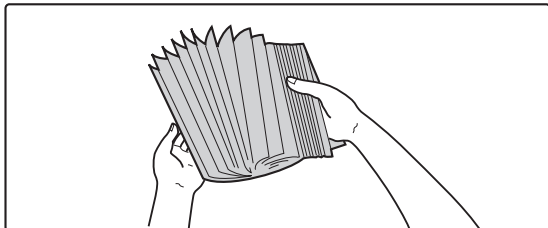

### Fan the paper.

Fan the paper well before loading it. If the paper is not fanned, multiple sheets may feed at once and cause a misfeed.

4

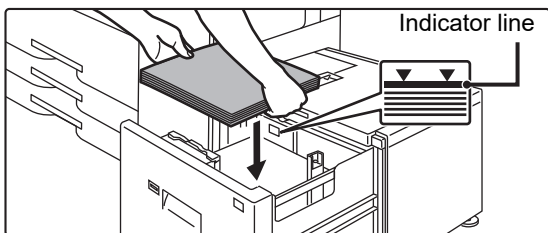

### Place the paper in the centre of the paper table.

Load the paper with the print side facing down. The stack must not be higher than the indicator line (maximum of 3000 sheets).

When a certain volume of paper is loaded, the paper table automatically goes down slightly and stops. Repeat this operation in the same way to load paper.



## BEFORE USING THE MACHINE



- Do not insert your hand into the space inside the paper table when you load paper.

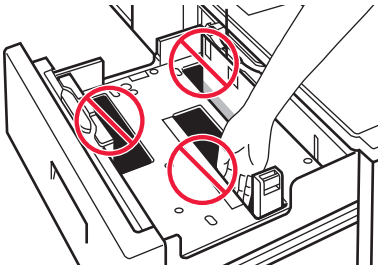

- Do not insert spare paper or objects into the space inside the tray.

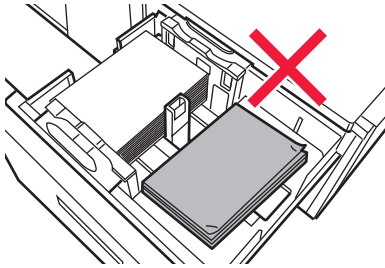

5

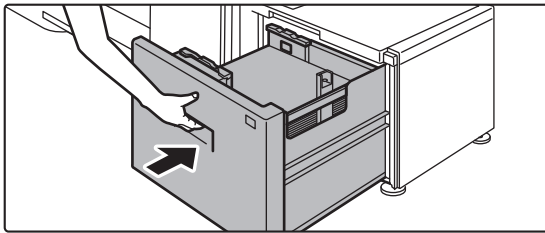

### Gently push the paper tray into the machine.

Push the tray firmly all the way into the machine slowly. Forcefully inserting the paper may cause skewed feeding and paper misfeeds. The paper table goes up after the tray is pushed in. The operation button blinks while the paper table goes up. The button lights up when the paper table has gone up.

## Large capacity trays

1

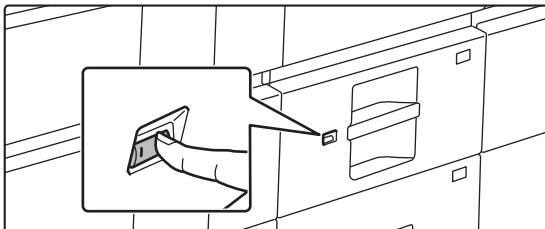

### Press the operation button.

The operation button blinks, and the tray paper table goes down to the paper loading position. Wait until the operation button light goes off.



Do not pull out the tray until the light goes off. If you pull out the tray forcibly while the button lights up or blinks, a machine failure may be resulted.



2

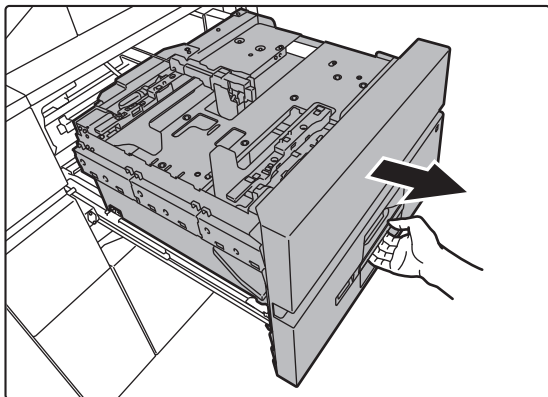

### Pull out the paper tray.

Gently pull the tray out until it stops.

3

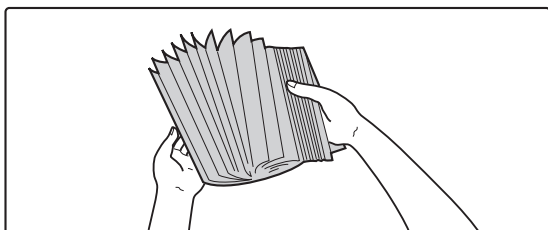

### Fan the paper.

Fan the paper well before loading it. If the paper is not fanned, multiple sheets may feed at once and cause a misfeed.

4

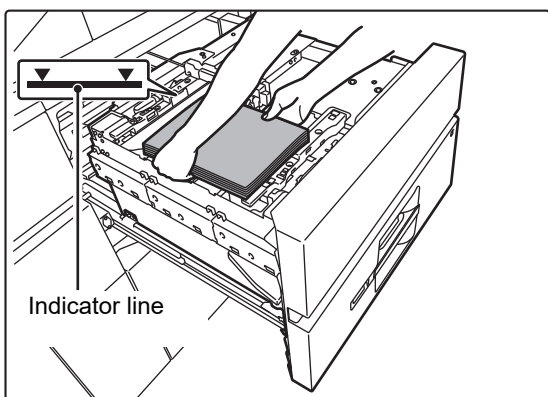

### Load the paper.

Load the paper with the print side facing down. The stack must not be higher than the indicator line (maximum of 2500 sheets).

5

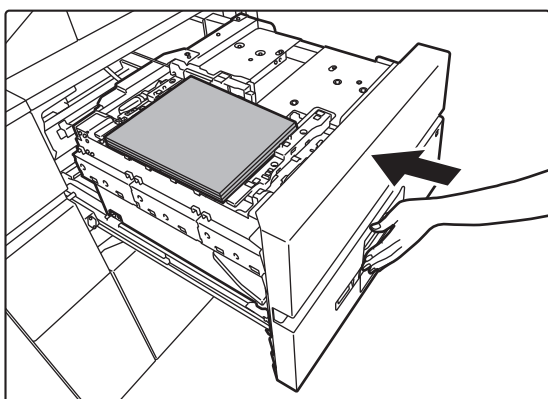

### Gently push the paper tray into the machine.

Push the tray firmly all the way into the machine slowly. Forcefully inserting the paper may cause skewed feeding and paper misfeeds.

The paper table goes up after the tray is pushed in. The operation button blinks while the paper table goes up. The button lights up when the paper table has gone up.



## CHANGE THE SETTING OF THE PAPER TRAY

To change the paper loaded in the tray, change the machine's tray settings from [Tray Settings/Paper Settings] in the home screen.

As an example, the steps for changing the paper in tray 3 from B4 plain paper to A4 recycled paper are explained below.

1



Tap the [Home Screen] key.

Home screen appears.

2

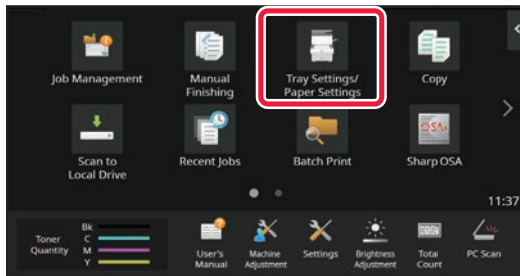

Tap the [Tray Settings/Paper Settings] key and tap the key of the paper tray 3.

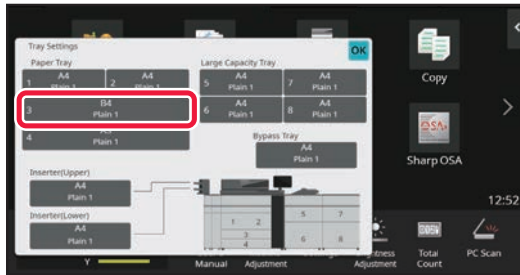

3

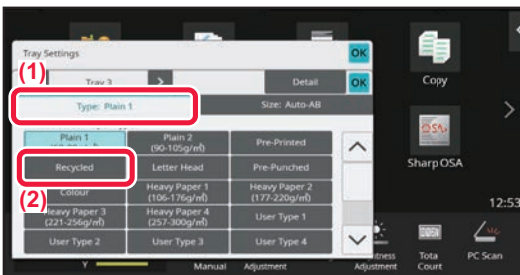

Set the paper type.

(1) Tap the tab for the Paper Type.

(2) Tap the [Recycled] key.

4



Set the paper size.

(1) Tap the tab for the Paper Size.

(2) Tap the [Auto-AB] key.

(3) Tap **OK** in "Tray Settings/Paper Settings".





# SAVING CONTACTS IN THE ADDRESS BOOK

"Contacts" and "Group" can be stored in the address book.

The procedure for adding a new contact to the address book by directly entering the name and address is explained here as an example.

1



Tap the [Home Screen] key.

Home screen appears.

2

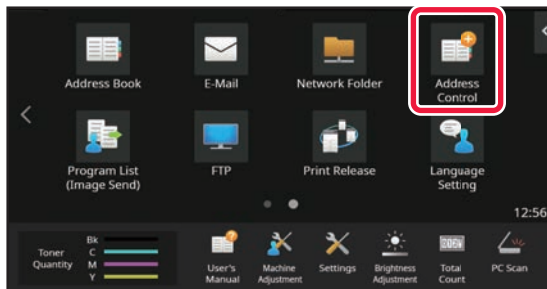

Tap the [Address Control] key.

3

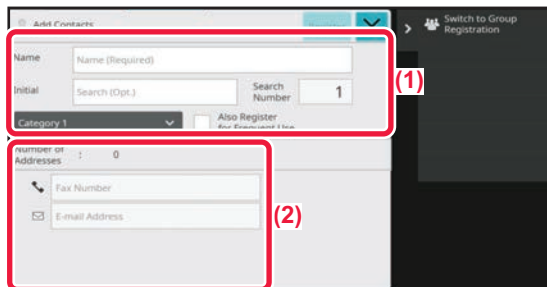

Enter the information you want to register in the address book.

(1) Enter basic information.

Be sure to enter [Name] and [Initial].

To specify a category, select one from a category list that appears when the entry box is tapped.

To register a contact for frequent use, select the [Also Register for Frequent Use] checkbox .

(2) Tap [E-mail Address], enter the address, and tap **OK**.

4

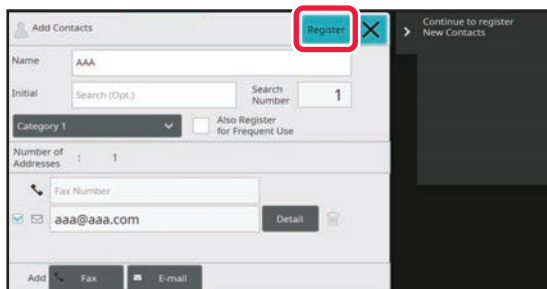

Tap the [Register] key.

The first address of each address type is set as the default address. If no address has the checkbox next to it selected, a confirmation screen will appear asking you if you want to select a default address.

## Editing or deleting a contact

Tap the [Address Book] key in the home screen, select the contact to be edited or deleted, tap  in the action panel, and tap [Edit] or [Delete].

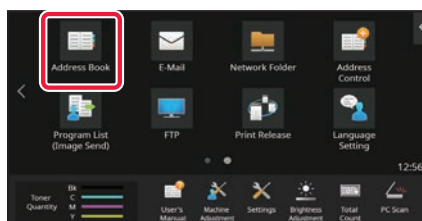



## ACCESSING THE WEB SERVER IN THE MACHINE

When the machine is connected to a network, the machine's built-in Web server can be accessed from a Web browser on your computer.

### OPENING THE WEB PAGES

1

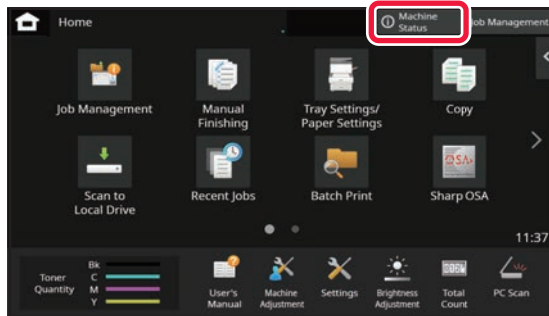

Tap the [Machine Status] key.

2

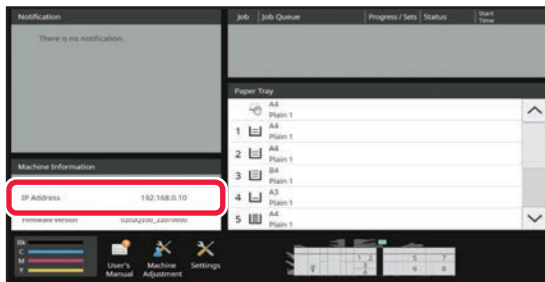

Check the IP address in the machine information.

3

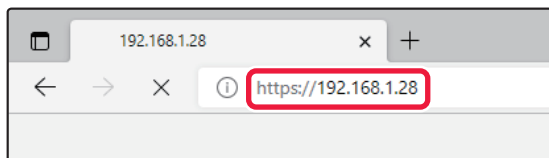

Access the Web server in the machine to open the Web pages.

Start a Web browser on a computer that is connected to the same network as the machine and enter the IP address of the machine.

Recommended Web browsers

Microsoft Edge (Windows®), Firefox (Windows®), Safari (macOS®), Chrome (Windows®):

Latest version or immediately previous major release

The Web page will appear.

User authentication may be required depending on the settings of this machine. Check with the administrator of this machine for information such as passwords required for user authentication.



# USER AUTHENTICATION

When user authentication is enabled in settings mode, you must log in in order to use the machine. User authentication is disabled in the factory default settings.

When you have finished using the machine, log out.

## ABOUT AUTHENTICATION METHODS

There are three user authentication methods: authentication by user number, authentication by login name / password, and authentication by quick authentication. Ask the system administrator of the machine for the information you need to log in.

### AUTHENTICATION BY USER NUMBER

The following procedure is used to log in using a user number received from the administrator of the machine.

When starting the machine, the login screen appears.

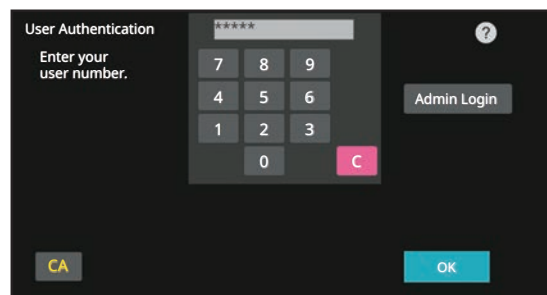

### AUTHENTICATION BY LOGIN NAME/PASSWORD

This method enables users to log in using a login name and password received from the administrator of the machine or the administrator of the LDAP server.

When starting the machine, the login screen appears.

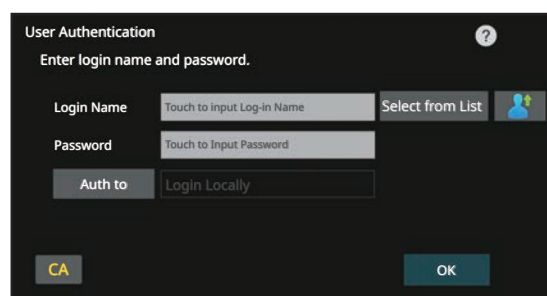

### AUTHENTICATION BY QUICK AUTHENTICATION

This can only be used on the machine when carrying out user authentication. This method provides simple authentication for an administrator who has been previously registered on the machine.

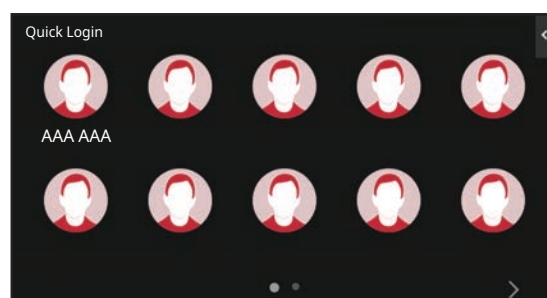

## Logout

When you have finished using the machine, log out. This helps prevent unauthorised people from using the machine.

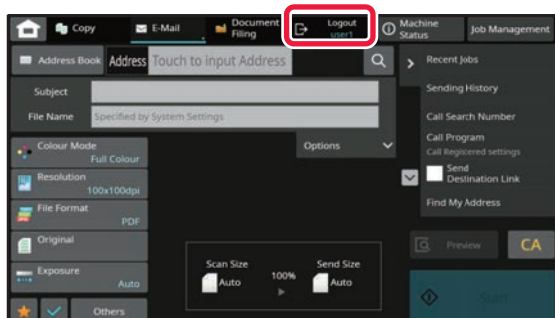



## INSTALLING THE PRINTER DRIVER

This section overviews the Standard installation and Advanced installation for Windows. See the Software Setup Guide for details on other Windows installations and macOS installations.

### If you obtained the software from our website or your dealer

- (1) Extract the installer that you obtained, and double-click the [Setup] icon (  ) in the [Printer] folder.

If you have already installed a similar type of driver, an install type selection screen will appear.

- To install the printer driver, click [Add a new Sharp printer].
- To update a previously installed driver, click [Select Sharp Printer to Update].



### If the "Software CD-ROM" was included with the machine

- (1) Insert the CD-ROM in your computer, navigate to the CD-ROM, and double-click the [Setup] icon (  ).
- (2) The "SOFTWARE LICENSE" window will appear. Make sure that you understand the contents of the license agreement and then click the [Yes] button.



You can show the "SOFTWARE LICENSE" in a different language by selecting the desired language from the language menu. To install the software in the selected language, continue the installation with that language selected.

- (3) Read the message in the "Welcome" window and then click the [Next] button.
- (4) Click the [Printer Driver] button.

### Installing the printer driver

- (1) Click the [Standard installation] button or the [Advanced installation] button.

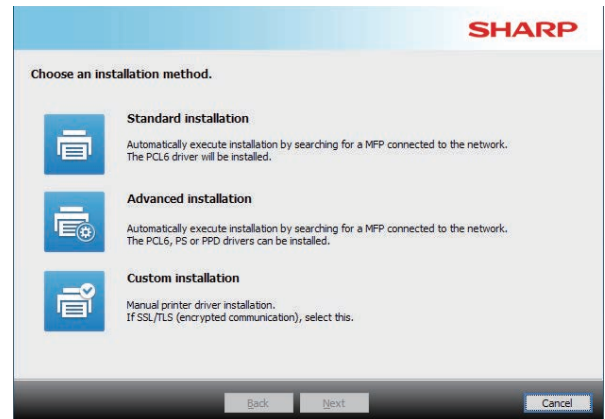

- (2) Select the machine and click the [Next] button.

You can also click the [Specify Condition] button and search for the machine by entering the machine's name (host name) or IP address, or selecting the search period.



- This screen is not displayed when only 1 device is found in the search results.
- If the machine is not found, make sure that the machine is powered on and that the machine is connected to the network, and then click the [Re-search] button.



**(3) Select the printer driver to be installed and click the [Next] button. (Advanced installation only)**

Click the checkbox of the printer driver to be installed so that a checkmark () appears.

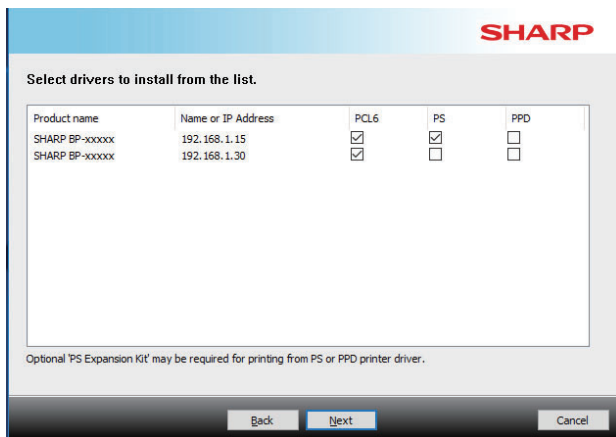

**(4) Check the contents and then click the [Next] button.**

When [Standard installation] or [Advanced installation] is selected, the installation will take place as indicated below.

- Machine connection method:  
LPR Direct Print (Auto Search)
- Printer driver:  
Standard installation:  
PCL6
- Advanced installation:  
Select from PCL6, PS, PPD
- Printer driver name:  
Cannot be changed
- Display fonts:  
Installed

**(5) Follow the on-screen instructions.**

Read the message in the window that appears and click the [Next] button.

Installation begins.

Set the [Run the Autoconfiguration] checkbox to  and install. The options of this machine and the condition of the peripherals can be reflected in the configuration.

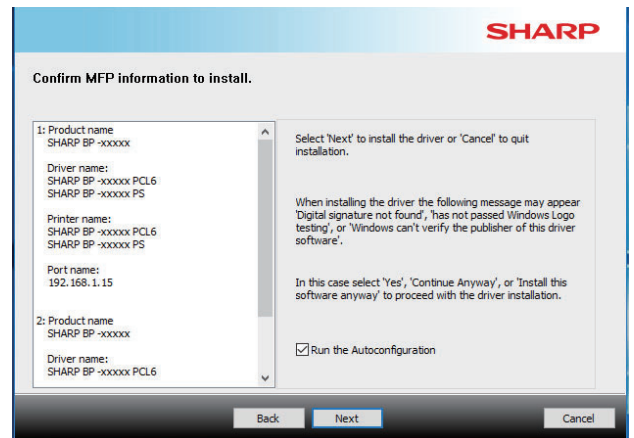

If a warning window regarding security is displayed, do not forget to click [Install].

**(6) When the installation completed screen appears, click the [Finish] button.**

- To set the installed driver as the default printer, select the name of the machine from "Set as default printer". If you don't want to change the default printer, select [Don't change].
- To print a test page, click [Print test page]. (Printer driver only)

**This completes the installation.**

After the installation, a message prompting you to restart your computer may appear. If this message appears, click the [Yes] button to restart your computer.



# COPIER

This section explains the basic procedures for using the copier function.

## MAKING COPIES

This section explains how to set a 2-sided copy.

1



### Tap the [Home Screen] key.

Home screen appears.

2

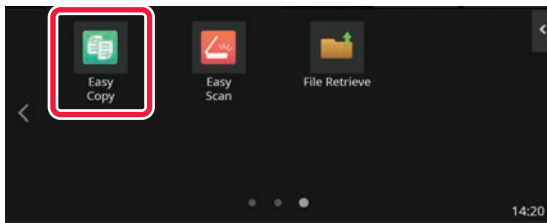

### Tap the [Easy Copy] mode icon.

Add the Easy Copy icon to the Home Screen in advance. See the User's Manual for information on how to add the Easy Copy icon.

Easy Copy mode screen appears.

Copy mode has two modes: easy mode and normal mode.

Easy mode is limited to frequently used functions that allow you to smoothly perform most copy jobs.

If you need to select detailed settings or special functions, use normal mode. All functions can be used in normal mode.

3

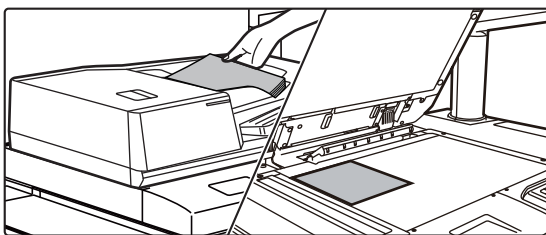

### Place the original.

Place the original in the document feeder tray of the automatic document feeder, or on the document glass.

▶ [PLACING ORIGINALS \(page 12\)](#)



4

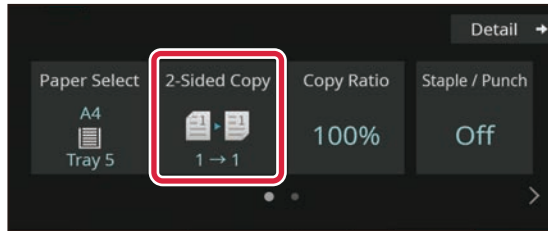

## Tap the [2-Sided Copy] key.

The functions below can be enabled in easy mode.

- Paper Select
- 2-Sided Copy
- Copy Ratio
- Staple\*1, Staple / Punch\*2
- Colour Mode
- Original
- Exposure
- N-Up
- Card Shot
- Job Build
- Blank Page Skip
- Dual Page Copy

\*1 When a finisher and saddle stitch finisher are installed.

\*2 When a punch module, finisher and saddle stitch finisher are installed.

To select more detailed settings, tap the [Detail] key and select settings in normal mode.

5

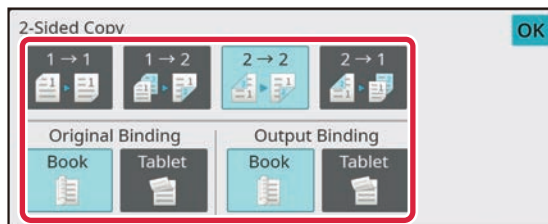

## Set the 2-Sided Copy.

After the settings are completed, tap [OK].

6

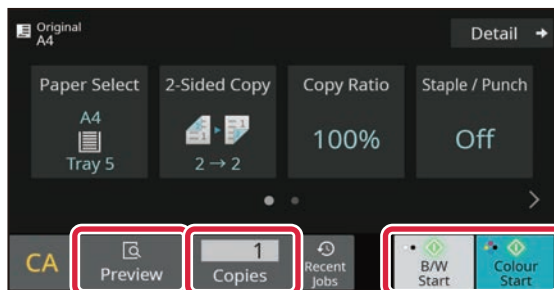

## Set the number of copies and then tap the [Colour Start] key or [B/W Start] key.

- In the factory default state, the machine detects whether the original is black & white or full colour when you tap the [Colour Start] key, and automatically switches between full colour and black & white binary scanning. When you tap the [B/W Start] key, the machine scans in black & white binary. For details, see the User's Manual.
- To check a preview of a document, tap the [Preview] key.
  - ▶ [PREVIEW SCREEN \(page 11\)](#)

Cancel copying



Cancel Copy



# COPYING ON SPECIAL PAPER (Bypass Copy)

This section explains how to load A4 heavy paper in the bypass tray.

1

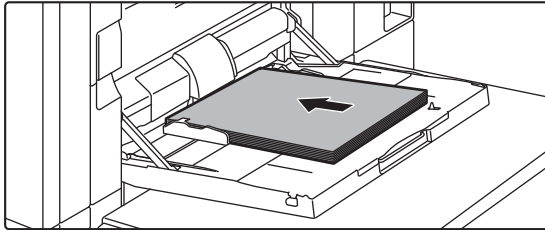

## Load paper into the bypass tray.

► [Bypass tray \(on the machine\) \(page 17\)](#)

2

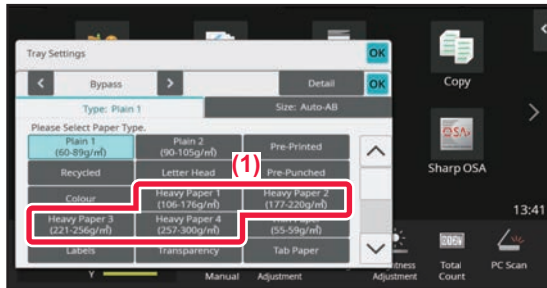

## Select settings in the touch panel.

(1) Tap the [Heavy Paper 1], [Heavy Paper 2], [Heavy Paper 3] or [Heavy Paper 4] key.

Select the paper weight according to the weight of the heavy paper to be loaded.

106 g/m<sup>2</sup> to 176 g/m<sup>2</sup> (28 lbs. bond to 65 lbs. cover):

[Heavy Paper 1]

177 g/m<sup>2</sup> to 220 g/m<sup>2</sup> (65 lbs. cover to 80 lbs. cover):

[Heavy Paper 2]

221 g/m<sup>2</sup> to 256 g/m<sup>2</sup> (80 lbs. cover to 140 lbs. index):

[Heavy Paper 3]

257 g/m<sup>2</sup> to 300 g/m<sup>2</sup> (140 lbs. index to 110 lbs. cover):

[Heavy Paper 4]

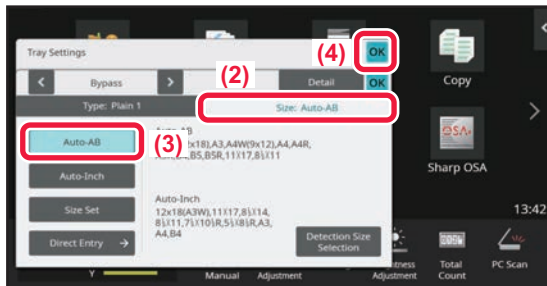

(2) Tap the [Size: Auto-AB] tab.

(3) Tap the [Auto-AB] key.

(4) Tap [OK] of "Tray Settings".

3

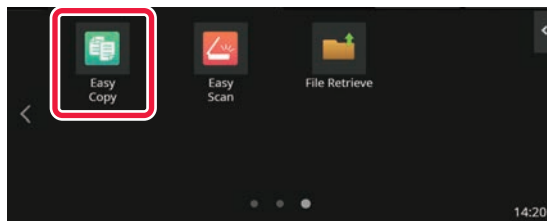

## Tap the [Easy Copy] mode icon.

Add the Easy Copy icon to the Home Screen in advance. See the User's Manual for information on how to add the Easy Copy icon.

Easy Copy mode screen appears.





4

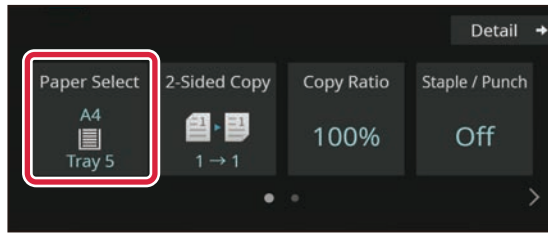

Tap the [Paper Select] Key.

5

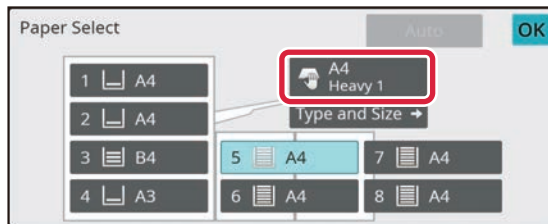

Select the Bypass Tray.

6

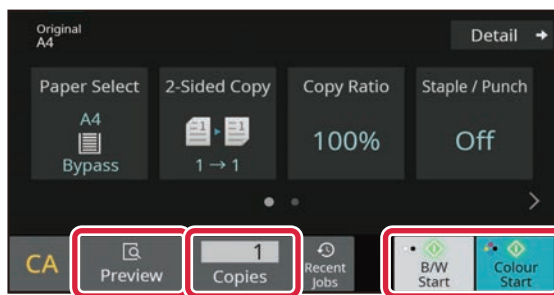

Set the number of copies and then tap the [Colour Start] key or [B/W Start] key.

- In the factory default state, the machine detects whether the original is black & white or full colour when you tap the [Colour Start] key, and automatically switches between full colour and black & white binary scanning. When you tap the [B/W Start] key, the machine scans in black & white binary. For details, see the User's Manual.
- To check a preview of a document, tap the [Preview] key.
  - ▶ [PREVIEW SCREEN \(page 11\)](#)

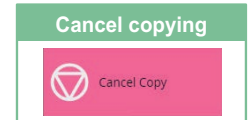
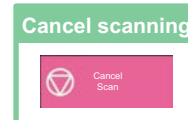



# PRINTER

This section explains the basic procedure for printing using the printer driver of the machine. The explanations of screens and procedures are primarily for Windows® 10 in Windows® environments, and macOS 11 in macOS environments. The window varies depending on the operating system version, the printer driver version, and the application.

## PRINTING IN A WINDOWS ENVIRONMENT

The following example explains how to print an A4 size document from "WordPad", which is a standard accessory program in Windows.

To install the printer driver and configure settings in a Windows environment, see the Software Setup Guide. For information on the available printer drivers and the requirements for their use, see the User's Manual.

1

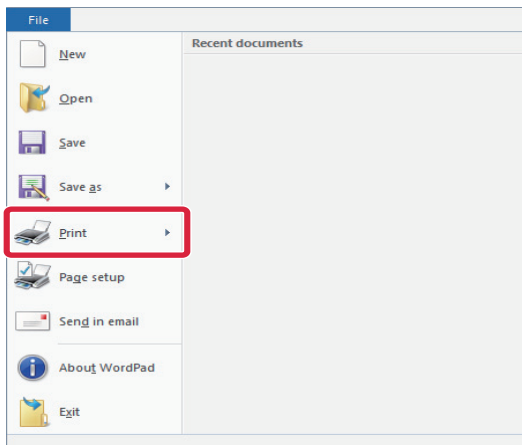

Select [Print] from the [File] menu of WordPad.

2

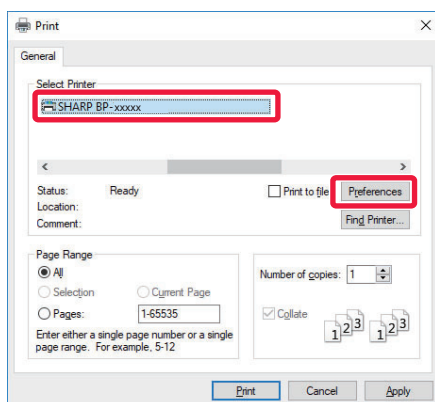

Select the machine's printer driver, and click the [Preferences] button.

If the printer drivers appear as a list, select the name of the printer driver to be used from the list.



3

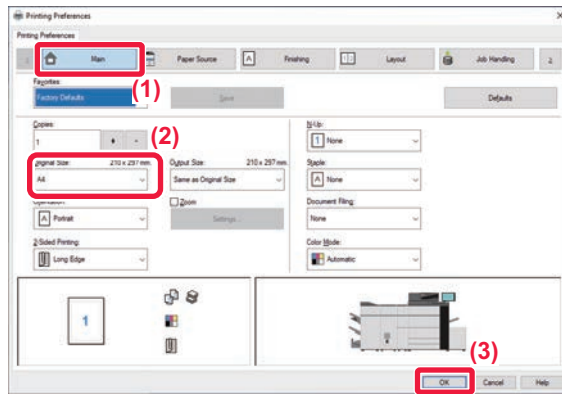

### Select print settings.

(1) Click the [Main] tab.

(2) Select the original size.

To select settings on other tabs, click the desired tab and then select the settings.

(3) Click the [OK] button.

- Help can be displayed for a setting by clicking the setting and pressing the [F1] key.
- Click the [Help] button, the Help window will open to let you view explanations of the settings on the tab.

4

### Click the [Print] button.

Printing begins.

## PRINTING ON ENVELOPES

The bypass tray or the tray 4 can be used for envelope printing.

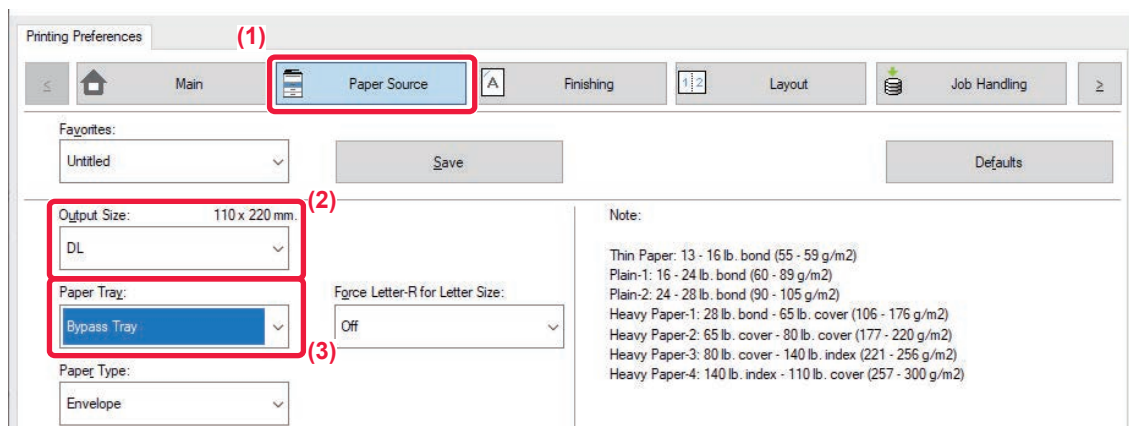

(1) Click the [Paper Source] tab.

(2) Select the envelope size from "Output Size".

When "Output Size" is set to [DL], "Paper Type" is also automatically set to [Envelope].

(3) Select [Bypass Tray] or the [Tray 4] from the "Paper Tray".



- Tray 4 can only be loaded with Com9, Com10, and Monarch envelopes.
- Set the paper type of the bypass tray or the tray 4 to [Envelope] and load an envelope into the bypass tray or the tray 4.
  - ▶ [Loading envelopes \(page 19\)](#)
- When using media such as envelopes that can be loaded only in a specific orientation, you can rotate the image 180 degrees. For more information, see "User's Manual".



# PRINTING IN A macOS ENVIRONMENT

The following example explains how to print an A4 size document from "TextEdit", which is a standard accessory program in macOS.

To install the printer driver and configure settings in a macOS environment, see the Software Setup Guide.

1

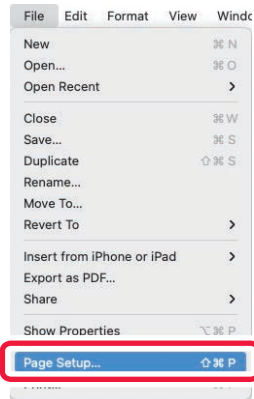

Select [Page Setup] from the [File] menu.

2

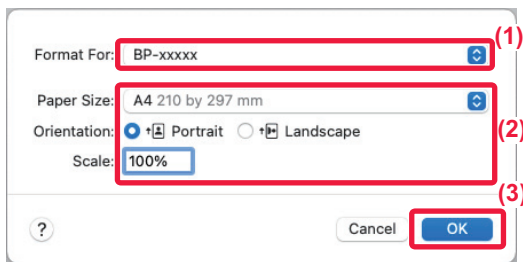

Select paper settings.

- (1) Make sure that the correct printer is selected.
- (2) Select the paper settings.  
Set the paper size, paper orientation, and copy ratio.
- (3) Click the [OK] button.

3

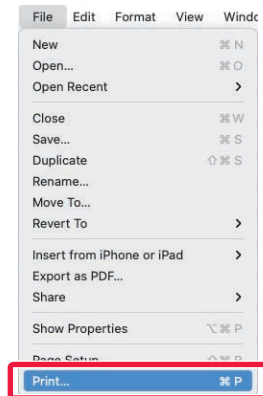

Select [Print] from the [File] menu.



4

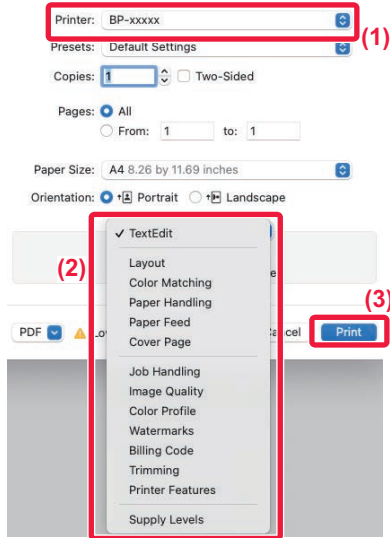

Select print settings.

- (1) Make sure that the correct printer is selected.
- (2) Select items from the menu and configure the settings as needed.
- (3) Click the [Print] button.

PRINTING ON ENVELOPES

The bypass tray or the tray 4 can be used for envelope printing.

Select the envelope size in the settings of the application ("Page Setup" in many applications) and then perform the following steps.

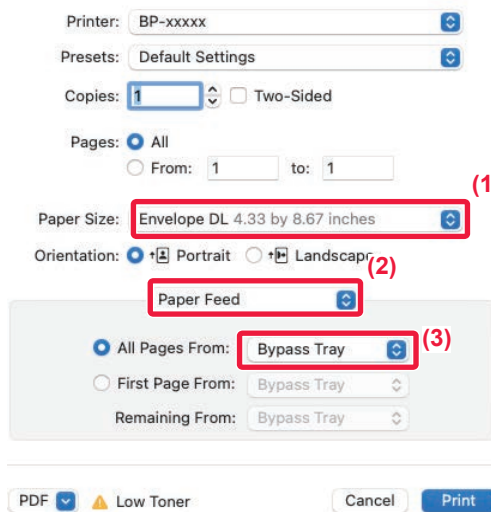

- (1) Select the envelope size from "Paper Size".
- (2) Select [Paper Feed].
- (3) Select [Bypass Tray] or the [Tray 4] from the "All Page From".



- Tray 4 can only be loaded with Com9, Com10, and Monarch envelopes.
- Set the paper type of the bypass tray or the tray 4 to [Envelope] and load an envelope into the bypass tray or the tray 4.
  - ▶ [Loading envelopes \(page 19\)](#)
- When using media such as envelopes that can be loaded only in a specific orientation, you can rotate the image 180 degrees. For more information, see "User's Manual".



# SCANNER

This section explains the uses of the network scanner function and the basic procedure for using scan mode.

## NETWORK SCANNER FUNCTION

The network scanner function of the machine can be used to transmit scanned images by a variety of methods.

The network scanner function has the following modes.

To use a mode, tap the button of the mode in the home screen.

If the button you want to use does not appear, tap or to change the screen.

### Scan modes



To send an image to an e-mail address, use

#### Scan to E-mail



To upload an image to an FTP server, use

#### Scan to FTP



To send an image to a shared folder on your computer, use

#### Scan to Network Folder

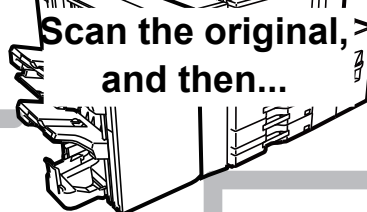

### USB memory mode

Use this mode to save an image to USB memory



### PC scan mode

Use this mode to scan a photo while making corrections on your computer



A TWAIN-compliant software application can be used.

### Data entry mode

If you want to use a document solution linked to an application





# SCANNING AN ORIGINAL

The basic operation for scanning is explained below.

The procedure for sending a scanned file by E-mail to a destination stored in the address book is explained here.

1



## Tap the [Home Screen] key.

Home screen appears.

2

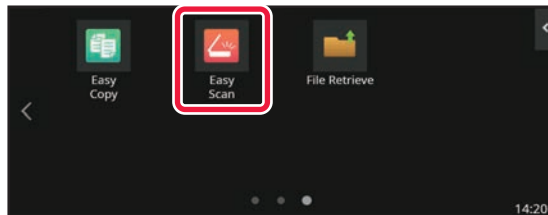

## Tap the [Easy Scan] mode icon.

Add the Easy Scan icon to the Home Screen in advance. See the User's Manual for information on how to add the Easy Scan icon. Easy Scan mode screen appears.

Scanner mode has two modes: easy mode and normal mode.

Easy mode is limited to frequently used functions that allow you to smoothly perform most scan jobs.

If you need to select detailed settings or special functions, use normal mode.

▶ [Easy Mode and Normal Mode \(page 9\)](#)

3

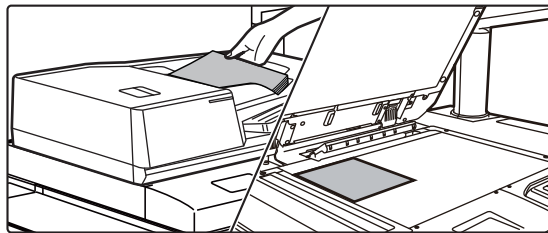

## Place the original.

Place the original in the document feeder tray of the automatic document feeder, or on the document glass.

▶ [PLACING ORIGINALS \(page 12\)](#)

4

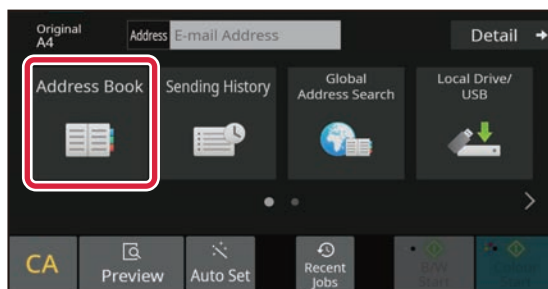

## Tap the [Address Book] key.

5

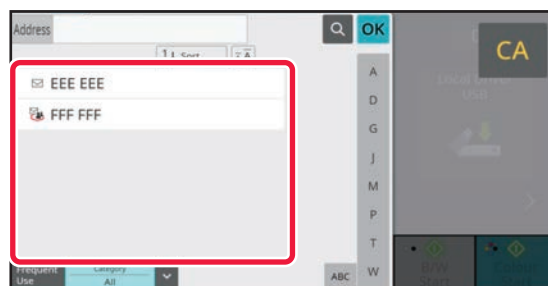

## Tap the key of the desired destination.

Addresses of the current mode are selected from addresses whose checkboxes were selected when the tapped destination was registered. If no addresses were registered with the checkbox selected, tap the [Yes] key in the confirmation screen and select the desired addresses.

To add another destination, tap the key of the destination.





6



### Tap the [All Destinations] key.

A list of the selected destinations appears.

7



### Confirm the destination.

If an incorrect destination appears in the list, tap the destination and then tap the [Delete] key.

8

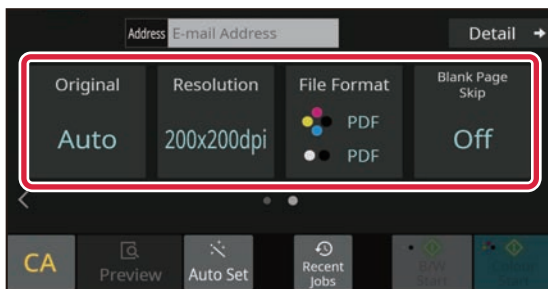

### Tap to change screens and select settings.

Change settings as needed.

The functions below can be enabled in easy mode.

- Original
- Resolution
- File Format
- Blank Page Skip

To select more detailed settings, tap the [Detail] key and select settings in normal mode.

▶ [Easy Mode and Normal Mode \(page 9\)](#)

9

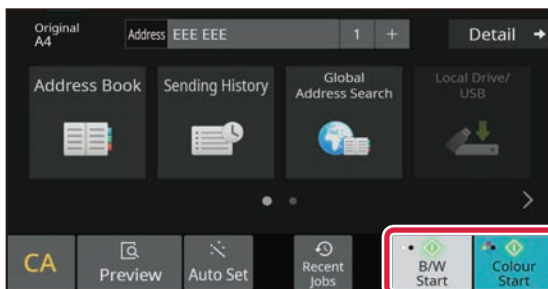

### Tap the [Colour Start] key or [B/W Start] key.

- In the factory default state, the machine detects whether the original is black & white or full colour when you tap the [Colour Start] key, and automatically switches between full colour and black & white binary scanning. When you tap the [B/W Start] key, the machine scans in black & white binary. For details, see the User's Manual.

- To check a preview of a document, tap [OK] to return to the base screen of Easy Scan and tap the [Preview] key.

▶ [PREVIEW SCREEN \(page 11\)](#)

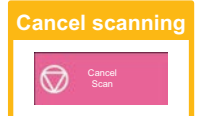





# DOCUMENT FILING

The document filing function is used to store the document or print image on the storage when performing a copy, print, or other job. You can print or perform other operations using the saved file at a later time. This section introduces several of the document filing functions.

## SAVING A DOCUMENT ONLY (Scan to Local Drive)

Scan to Local Drive lets you save a scanned document to the main folder or a custom folder. This function is not used to print or send.

The procedure for storing a document in the main folder is explained below.

To save to a custom folder, tap the [File Retrieve] key in the Home screen, tap [Scan to Local Drive] on the action panel, and select save settings. For more information, see the User's Manual.

### Saving by Easy Scan

You can save a file in the main folder or My Folder (when user authentication is enabled).

1



**Tap the [Home Screen] key.**

The Home screen appears.

2

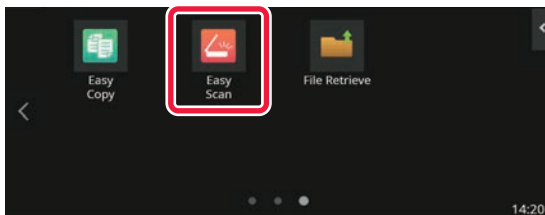

**Tap the [Easy Scan] mode icon.**

Add the Easy Scan icon to the Home Screen in advance. See the User's Manual for information on how to add the Easy Scan icon.

3

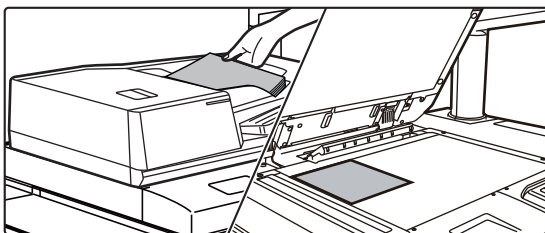

**Place the original.**

Place the original in the document feeder tray of the automatic document feeder, or on the document glass.

▶ [PLACING ORIGINALS \(page 12\)](#)



4

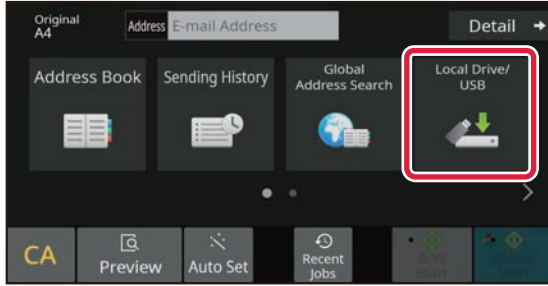

Tap the [Local Drive/USB] key.

5

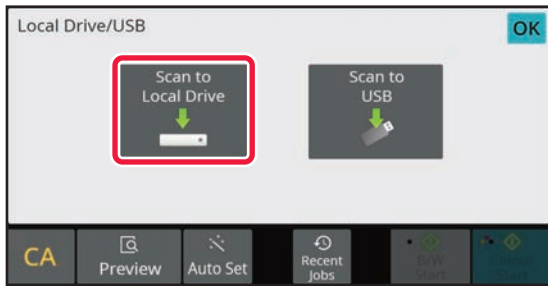

Tap the [Scan to Local Drive] key.

6

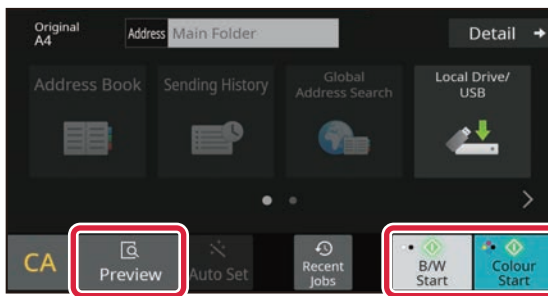

Tap the [Colour Start] key or [B/W Start] key.

To check a preview of a document, tap the [Preview] key.

▶ [PREVIEW SCREEN \(page 11\)](#)

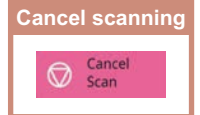



# PRINTING A SAVED FILE

You can retrieve a file stored by document filing and print or transmit the file.

You can also print files saved in a USB memory device or a shared folder.

The steps for printing the "Scan\_20211010\_101010" file saved in the main folder are explained below.

1



**Tap the [Home Screen] key.**

Home screen appears.

2

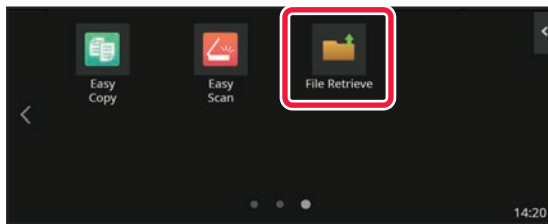

**Tap the [File Retrieve] mode icon.**

Add the File Retrieve icon to the Home Screen in advance. See the User's Manual for information on how to add the File Retrieve icon.

3

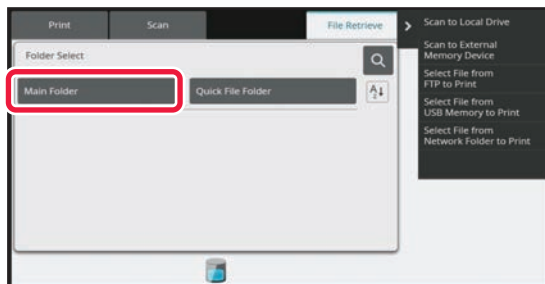

**Select the file and print.**

**(1) Tap the [Main Folder] key.**

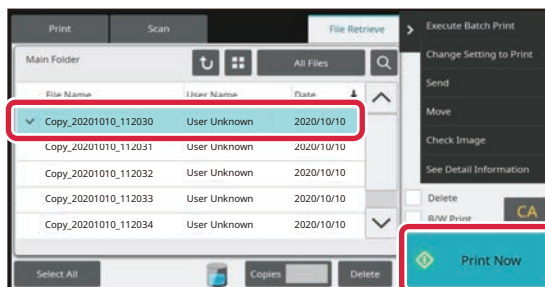

**(2) Tap the key of the file that you wish to print.**

In this case, tap the "Scan\_20211010\_101010" key. To check a preview of the printed image, tap [Check Image] on the action panel.

If you want to delete the file after printing, tap [Print and Delete the Data] on the action panel so that  appears.

**(3) Tap the [Print Now] key.**





# SETTING MODE

The setting mode let you adjust the operation of the machine to suit the needs of your workplace. This section briefly introduces several of the setting mode.

For detailed explanations of the system settings, see "SETTING MODE" in the User's Manual.

## SETTING MODE

The date and time can be set, scan destinations can be stored, document filing folders can be created, and various other settings related to the operation of the machine can be configured in the setting mode screen.

The procedure for opening the setting mode screen and the items in the screen are explained below.

## DISPLAYING THE SETTING MODE ON THE MACHINE

1



Tap the [Home Screen] key.

Home screen appears.

2

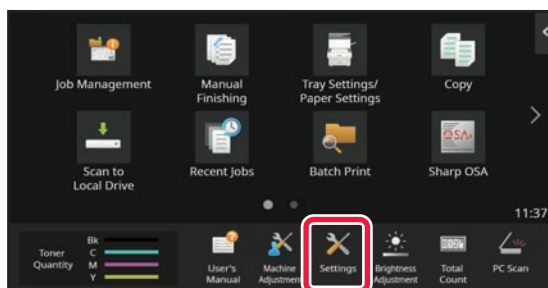

Tap the [Settings] key.

The setting mode screen appears.

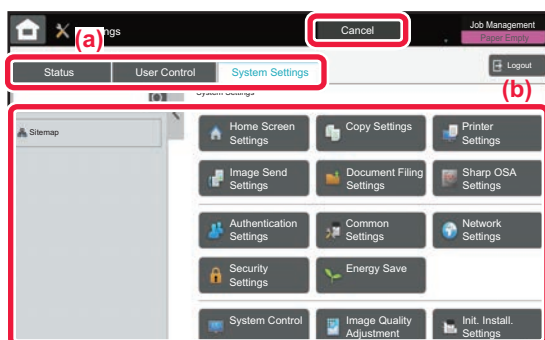

Tap the item that you want to set on menu tab (a) or setting menu (b).

To exit setting mode, tap the [Cancel] key.

▶ [SETTING MODE WHEN AN ADMINISTRATOR IS LOGGED IN \(page 45\)](#)



## SETTING MODE WHEN AN ADMINISTRATOR IS LOGGED IN

An administrator can configure settings that are more advanced than the settings available to a guest or user. When user authentication is enabled, settings may be allowed without entering the administrator password based on the rights of the logged in user. For the state of the settings, ask the administrator of the machine.



When you select an item in setting mode that requires administrator login, the administrator login screen will appear.

For the items available in setting mode when an administrator is logged in, see "SETTING MODE" in the User's Manual.

## DISPLAYING THE SETTING MODE ON THE WEB PAGE

For information on how to display web pages, see [ACCESSING THE WEB SERVER IN THE MACHINE \(page 26\)](#).

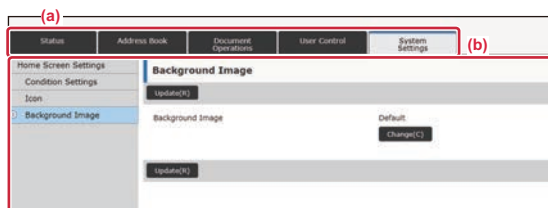

From the Menu tab (a) and the Settings menu (b), click the item you want to set.

To exit the setting mode, close your web browser.





# WHAT YOU CAN DO IN THE SETTING MODE

The following settings can be configured in setting mode.

Some settings may not appear on the touch panel of the machine, or in the Web browser on your computer. Some settings may not appear due to the specifications of your machine and the peripheral devices that are installed.

Menu	Overview	
Status	Displays paper tray information and device information.	
Address Book	Use to edit the address book.	
Document Operations	Use to perform actions on a file using the Document Filing function.	
User Control	This is used to store, edit, and delete users when user authentication is enabled.	
System Settings	Configure the main settings for the machine such as date settings and paper tray settings. You can configure the following settings.	
	Home Screen Settings	You can select settings for the machine's home screen, such as changing the home screen background.
	Copy Settings	You can select copy settings.
	Printer Settings	You can select print settings.
	Image Send Settings	Configure settings for image send, such as Scan to E-mail.
	Document Filing Settings	You can select Document Filing settings.
	Sharp OSA Settings	You can select Sharp OSA settings.
	Authentication Settings	Configure the user authentication method. Alternatively, configure the IC card.
	Common Settings	You can configure machine settings such as date settings and tray settings.
	Network Settings	You can configure network settings such as Interface Settings and NAS settings.
	Security Settings	You can configure machine security settings such as authentication and changing the administrator password.
	Energy Save	The machine's power consumption can be reduced by Eco Mode setting.
	System Control	You can configure machine backup and job log settings.
	Image Quality Adjustment	You can perform image adjustment on the machine.
Initial Installation Settings	This is a group of settings that are required when you initially install the machine.	

## Please note

- For information on your operating system, please refer to your operating system manual or the online Help function.
- The explanations of screens and procedures in a Windows environment are primarily for Windows 10®. The screens may vary depending on the version of the operating system or the software application.
- The explanations of screens and procedures in a macOS environment are based on macOS 11 in the case of macOS. The screens may vary depending on the version of the operating system or the software application.
- Wherever "BP-xxxx" appears in this manual, please substitute your model name for "xxxx".
- Considerable care has been taken in preparing this manual. If you have any comments or concerns about the manual, please contact your dealer or nearest authorised service representative.
- This product has undergone strict quality control and inspection procedures. In the unlikely event that a defect or other problem is discovered, please contact your dealer or nearest authorised service representative.
- Aside from instances provided for by law, SHARP is not responsible for failures occurring during the use of the product or its options, or failures due to incorrect operation of the product and its options, or other failures, or for any damage that occurs due to use of the product.

## Warning

- Reproduction, adaptation or translation of the contents of the manual without prior written permission is prohibited, except as allowed under copyright laws.
- All information in this manual is subject to change without notice.

## Illustrations and the operation panel and touch panel shown in this manual

The peripheral devices are generally optional, however, some models include certain peripheral devices as standard equipment. The explanations in this manual assume on the BP-90C80.

For some functions and procedures, the explanations assume that devices other than the above are installed.

<p>The display screens, messages, and key names shown in the manual may differ from those on the actual machine due to product improvements and modifications.</p>
--

# **SHARP**

SHARP CORPORATION